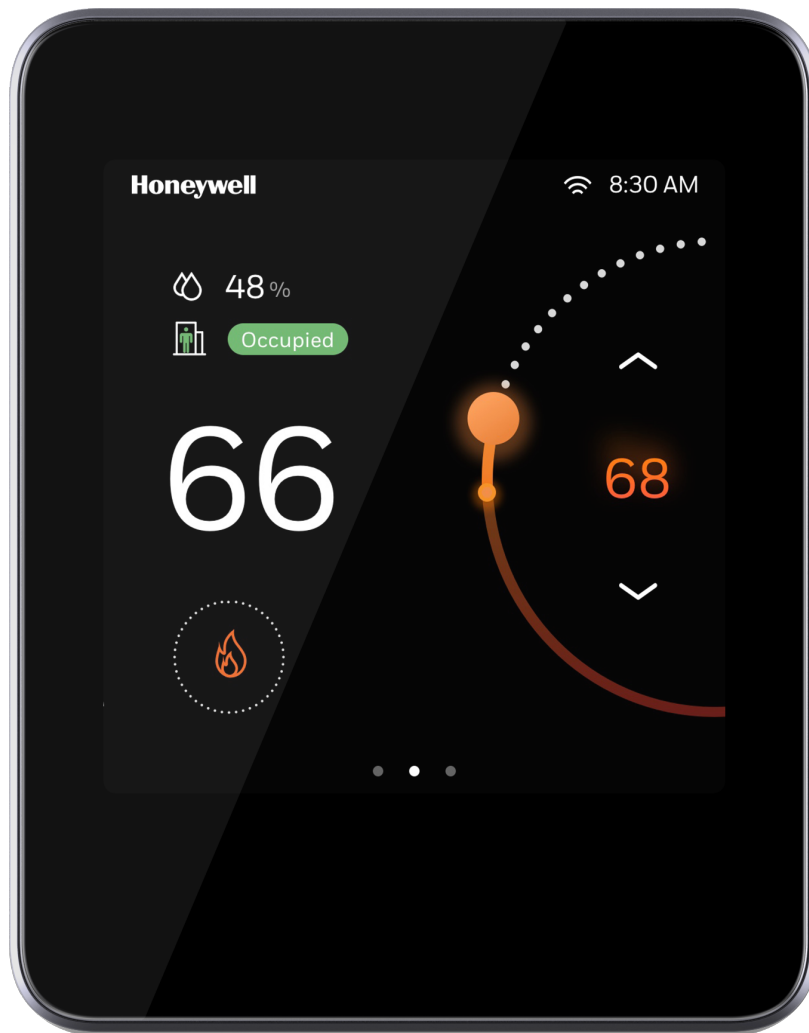


**Honeywell** | THE FUTURE IS WHAT WE MAKE IT

# TC500A Commercial Thermostat

CONNECTED DEVICE FOR COMMERCIAL BUILDINGS

## CONFIGURATION AND USER GUIDE





**Honeywell  
CONNECT ME**



**Honeywell Connect Mobile**  
Honeywell International, Inc.



# Table of contents

Important Safety Information and Installation Precautions.....	8
Introduction.....	11
About TC500A Thermostat .....	12
Features.....	12
Intended audience and assumed knowledge.....	12
Reference documents.....	13
Abbreviation and nomenclature.....	13
Conventions.....	14
Dimensions.....	15
Technical specifications.....	16
Terminal Identification .....	22
Terminal assignment.....	24
Security requirement.....	26
Getting started .....	27
Thermostat display overview .....	27
Presence detection.....	28
Home Page: Temperature reading and adjustment .....	28
Quick access page (right side page): Device configuration.....	30
Ambiance page (left side page): Sensor reading .....	31
Home screen icon overview.....	32
Smart LED indication.....	33
Initial Configuration.....	35
Prerequisites.....	36
Boot-up the thermostat .....	37
Honeywell Connect Mobile App.....	60

- Integrating with Occupant app and Cloud registration ..... 72
- Device Configuration & Equipment Settings ..... 77
  - Configuration page ..... 78
  - Basic configuration ..... 79
  - Configuring equipment ..... 87
  - Managing the internal economizer..... 110
  - Enabling the external economizer ..... 119
  - Advanced configuration ..... 120
  - Configuring the thermostat I/O terminals..... 121
  - Configuring the sensors ..... 123
  - Configuring the Sylk devices ..... 127
  - Configuring Delta T Diagnostics..... 131
  - Managing setpoint options..... 141
  - Configuring Purge ..... 143
  - Miscellaneous ..... 145
  - Enabling the Service mode ..... 147
  - Viewing the Security log ..... 149
  - Managing the thermostat connection..... 149
  - User management ..... 152
  - Configuring the user roles ..... 153
  - Configuring the alarm preference..... 160
  - Configuring Auto Demand Response ..... 161
  - Viewing the system status ..... 164
  - Configuring the Home page (Display Management) ..... 167
  - Reset to Default ..... 168
- Alarms ..... 171
  - Alarms ..... 171
  - Alarm notification signs ..... 171
  - Alert notification ..... 172
  - Unacknowledged alarms..... 172
  - Managing Delta T alarms..... 175
  - List of alarms and their severity ..... 177
  - Managing the alarms ..... 179
- Scheduling ..... 183

About Schedule ..... 183  
Setting up a weekly schedule..... 184  
Resetting a schedule..... 189  
Setting up a holiday schedule ..... 190  
Special event ..... 195



## Declaration


This document contains Honeywell proprietary information. Information contained herein is to be used solely for the purpose submitted, and no part of this document or its contents shall be reproduced, published, or disclosed to a third party without the express permission of Honeywell International Inc.

While this information is presented in good faith and believed to be accurate, Honeywell disclaims the implied warranties of merchantability and fitness for a purpose and makes no express warranties except as may be stated in its written agreement with and for its customer.

In no event is Honeywell liable to anyone for any direct, special, or consequential damages. The information and specifications in this document are subject to change without notice.

Copyright 2021 – Honeywell International Inc.

## Waste Electrical and Electronic Equipment (WEEE)

<b>WEEE: Waste Electrical and Electronic Equipment Directive</b>	
	<ul style="list-style-type: none"> <li>• At the end of the product life, dispose of the packaging and product in an appropriate recycling center.</li> <li>• Do not dispose of the device with the usual domestic refuse.</li> <li>• Do not burn the device.</li> </ul>

## FCC Part 15 compliant

This device complies with part 15 of the FCC Rules. Operation is subject to the following two conditions:

- (1) This device may not cause harmful interference, and
- (2) This device must accept any interference received, including interference that may cause undesired operation.

# Regulation (EC) No 1907/2006

According to Article 33 of Reach Regulation, be informed that the substances listed below may be contained in these products above the threshold level of 0.1% by weight of the listed article.

Product/Part Code	Substance Name	CAS Number
Only TC500A-W / thermostat mainboard CBA, thermostat wall plate board PCBA	Lead	7439-92-1
	Lead oxide	1317-36-8

## Important Safety Information and Installation Precautions

Read all instructions

Failure to follow all instructions may result in equipment damage or a hazardous condition. Read all instructions carefully before installing equipment.

When performing any work (installation, mounting, start-up), all manufacturer instructions and in particular the Mounting Instructions (31-00399M-02) are to be observed.

- TC500A Thermostat may be installed and mounted only by authorized and trained personnel.
- It is recommended that devices be kept at room temperature for at least 24 hours before applying power. This is to allow any condensation resulting from low shipping/storage temperatures to evaporate.
- Do not open TC500A Thermostat, as it contains no user-serviceable parts inside!
- Investigated according to United States Standard UL- 60730-1, and UL60730-2-9.
- Investigated according to Canadian National Standard(s) C22.2, No. 205-M1983 (CNL-listed).
- CE declarations according to LVD Directive 2014/35/EU and EMC Directive 2014/30/EU.
- Product standards are EN 60730-1 and EN 60730-2-9.
- TC500A Thermostat is Class B digital apparatus and complies with Canadian ICES-003.

### Local codes and practices

Always install equipment in accordance with the National Electric Code and in a manner acceptable to the local authority having jurisdiction.

### Electrostatic sensitivity

This product and its components may be susceptible to electrostatic discharge (ESD). Use appropriate ESD grounding techniques while handling the product. When possible, always handle the product by its non-electrical components.





### High voltage safety test

Experienced electricians, at first contact, always assume that hazardous voltages may exist in any wiring system. A safety check using a known, reliable voltage measurement or detection device should be made immediately before starting work and when work resumes.

### Lightning and high-voltage danger



Most electrical injuries involving low-voltage wiring result from sudden, unexpected high voltages on normally low voltage wiring. Low-voltage wiring can carry hazardous high voltages under unsafe conditions. Never install or connect wiring or equipment during electrical storms. Improperly protected wiring can carry a fatal lightning surge for many miles. All outdoor wiring must be equipped with properly grounded and listed signal circuit protectors, which must be installed in compliance with local, applicable codes. Never install wiring or equipment while standing in water.

### Wiring and equipment separations



All wiring and controllers must be installed to minimize the possibility of accidental contact with other potentially hazardous and disruptive power and lighting wiring. Never place 24VAC or communications wiring near other bare power wires, lightning rods, antennas, transformers, or steam or hot water pipes. Never place wire in any conduit, box, channel, duct or other enclosure containing power or lighting circuits of any type. Always provide adequate separation of communications wiring and other electrical wiring according to code. Keep wiring and controllers at least six feet from large inductive loads (power distribution panels, lighting ballasts, motors, etc.). Failure to follow these guidelines can introduce electrical interference and cause the system to operate erratically.



### Warning

By using this Honeywell literature, you agree that Honeywell will have no liability for any damages arising out of your use, or modification to, the literature. You will defend and indemnify Honeywell, its affiliates and subsidiaries, from and against any liability, cost, or damages, including attorneys' fees, arising out of, or resulting from, any modification to the literature by you.

The material in this document is for information purposes only. The content and the product it describes are subject to change without notice. Honeywell makes no representations or warranties with respect to this document. In no event shall Honeywell be liable for technical or editorial omissions or mistakes in this document, nor shall it be liable for any damages, direct or incidental, arising out of or related to the use of this document. No part of this document may be reproduced in any form or by any means without prior written permission from Honeywell.

## Safety Information as per EN60730-1

TC500A Thermostat is intended for commercial and residential environments.

TC500A Thermostat is an independently mounted electronic control system with fixed wiring.

TC500A Thermostat is used for the purpose of building HVAC control and is suitable for use only in non-safety controls for installation on or in appliances.



# Introduction

This chapter contains brief description of the TC500A thermostat and its hardware specifications.

## Related topics

[About TC500A Thermostat](#)

[Features](#)

[Intended audience and assumed knowledge](#)

[Reference documents](#)

[Abbreviation and nomenclature](#)

[Conventions](#)

[Dimensions](#)

[Technical specifications](#)

[Terminal Identification](#)

[Terminal assignment](#)

[Security requirement](#)

## About TC500A Thermostat

TC500A-N Thermostat is an advanced, configurable, connected device for commercial buildings. It controls and monitors Rooftop Unit, Heat Pump equipment, and their accessories. This device communicates over Wi-Fi, Bluetooth, BACnet/IP over Wi-Fi, BACnet MS/TP, Sylk to easily integrate with the building automation system.

The built-in intelligent control algorithms of the device help to achieve the perfect balance between Energy Efficiency and Comfort. The device is packaged with numerous presets suitable for most commercial building requirements that enable the easy and quick initial setup.

The firmware of the device can be upgraded via Wi-Fi and MS/TP network. The device has four universal terminals and a pair of Sylk terminals to connect with sensors or other accessories. It also has a built-in temperature sensor, humidity sensor, and proximity sensor.

Users can connect to the thermostat via Wi-Fi with the Honeywell Connect Me app. The Honeywell Connect Me app gives authorized users access to the Honeywell TC500 Thermostats in their commercial buildings. They can remotely monitor sites, schedules, settings, and override controls. Users can add and configure devices, manage users and more – all from a mobile device.

## Features

- Easily customizable and intuitive user interface.
- Multiple, configurable, levels of user privilege access for features such as Occupancy set points, Date/Time, Schedules, Calendars of special events, remote and local Manual Override, remote and local Occupancy Override, Choice of language and units, and screen lockouts to prevent unauthorized settings changes.
- Advanced commercial control algorithms such as changeover, scheduled purge, power-up delay, freeze protection, demand limit controls, and same reliable optimized recovery methods established over decades of use.
- Settings to switch Fahrenheit to Celsius and vice-versa.
- Heat setpoints are limited automatically between 40°F to 90°F and cool setpoints are limited automatically between 50°F to 99°F
- Auto display goes into sleep mode when there is no user action.
- A LED indicator to show the operational status of the thermostat when the display goes to sleep mode.
- Real Time Clock time keeping accuracy with 72 hour retention during power loss.
- Thermostat can be configured via HMI, the Honeywell Connect Mobile app, or BACnet.
- BACnet settings can be configured via HMI or the Honeywell TC500A BACnet Wizard tool.

## Intended audience and assumed knowledge

This document provides information about installing and commissioning a TC500A Thermostat. It also shows how to operate the user interface.

It is assumed that the user is trained and familiar with HVAC concepts.

**IMPORTANT:** Always install equipment in accordance with the National Electric Code and in a manner acceptable to the local authority having jurisdiction (AHJ). No guidelines, instructions, installation practices, or other information presented in this

guide may be interpreted to supersede or modify the local codes and practices of the AHJ.

## Reference documents

- TC500A Commercial Thermostat Datasheet (31-00398M)
- TC500A Commercial Thermostat Mounting instructions (31-00399M)
- TC500A Commercial Thermostat Quick start guide (31-00401M)
- TC500A Commercial Thermostat Pocket guide (31-00463M)
- TC500A Deco Plate Pocket guide (31-00457M)
- TC500A BACnet Integration guide (31-00478)

## Abbreviation and nomenclature

Abbreviation	Definition
AHU	Air Handling Unit
RTU	Roof Top Unit
VAC	Volts AC (Alternating Current)
VDC/ DC	Volts DC (Direct Current)
OTW	Over-The-Wire
ETA	Serial Communication protocol
BMS	Building Management System

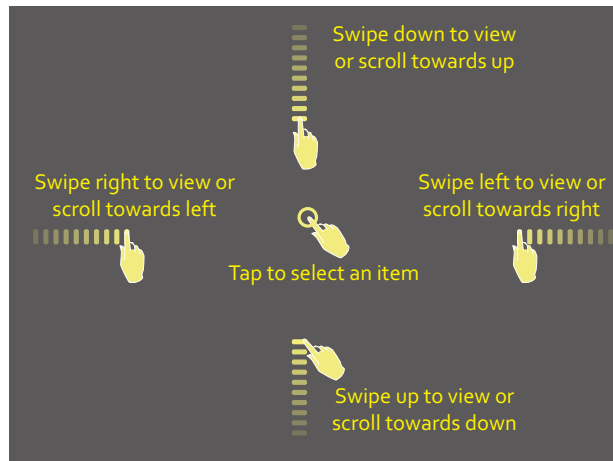
## Conventions

The TC500A thermostat has a 4 inch, 480x480 pixel LCD screen for easy navigation and setup. You can select various options available on the screen by lightly tapping the option on the screen or scrolling through the list.

The conventions for hand gestures used to navigate through the pages on the TC500A Thermostat display are:

- Tap: Quickly touch and release to select a control or item; equivalent to a mouse-click.
- Swipe: Quickly slide one or more fingers across the screen to reveal controls or to scroll through lists or groups of items; equivalent to scroll.

**Figure 1** Hand gestures convention



- A green tick appears before the valid selection
- If the option selected or the text entered is valid, the option to move to the subsequent screen turns blue. Tapping the option in blue will toggle to next screen.

# Dimensions

## Thermostat

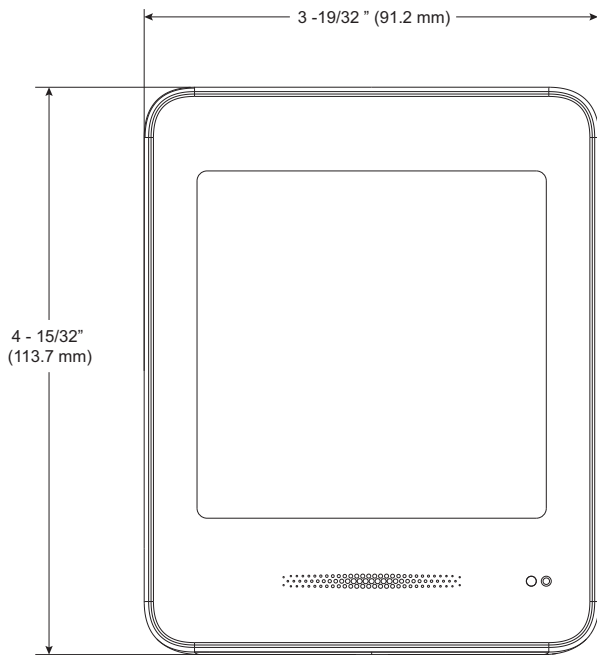
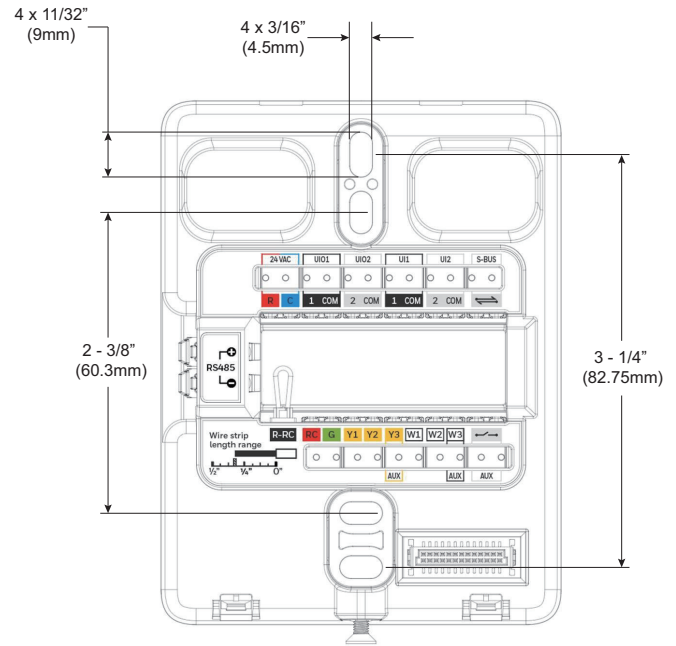
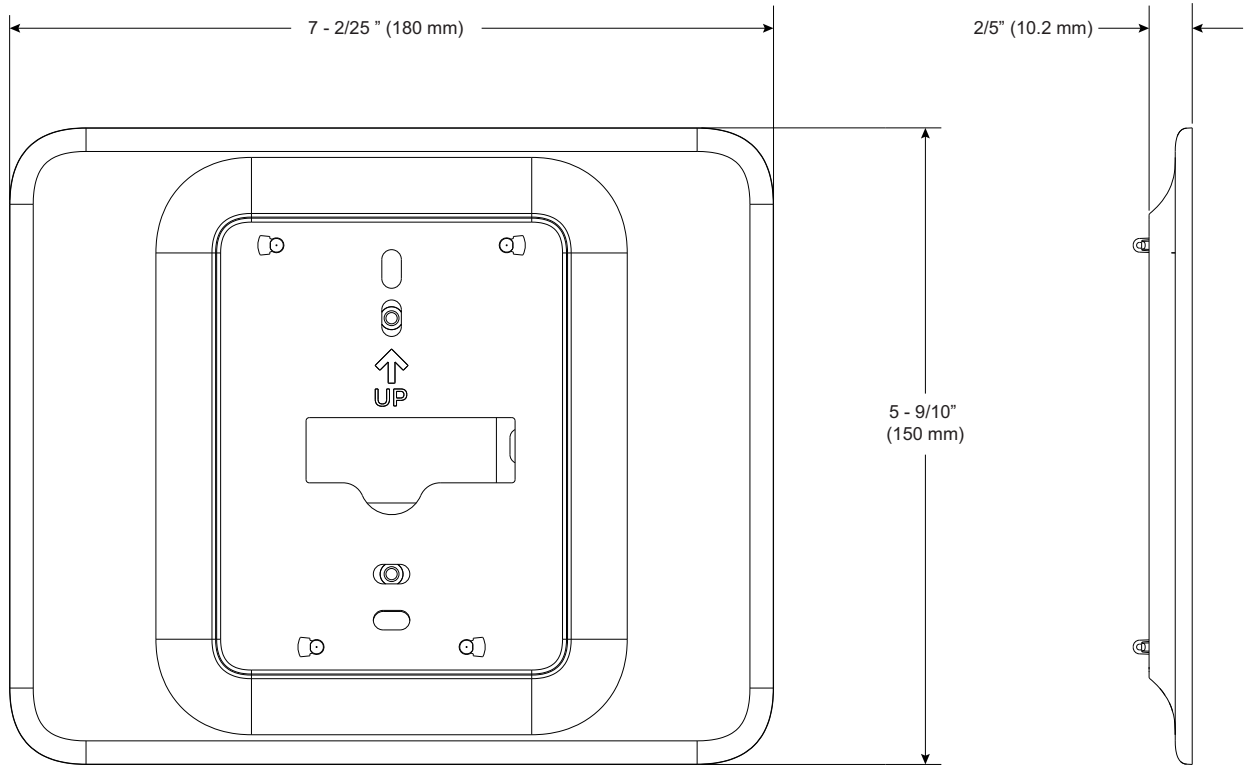


Figure 2 Dimensions



## Decoplate-N



## Technical specifications

### Power Characteristics

**Table 1: Power Characteristics**

Power Supply	Rated voltage: 24VAC 50/60Hz, Working voltage range: 20-30VAC, UL listed class-2 transformer or IEC 61558 listed transformer.
Power Consumption (Display ON)	Max. 8.5VA @ 24VAC (355mA @ 24VAC)
Min. Load	4VA (all DOs OFF)
Max. Load	96VA (all DOs ON)



## Display

**Table 2: Display**

Display Type	24 BPP TFT display with CTP
Resolutions	480x480 pixel
Active Display Area	4" diagonally
Backlight	LCD (Dimmable)

## Operating Environment

**Table 3: Operating Environment**

Ambient Operating Temperature	32 to 122 °F (0 to 50°C)
Ambient Operating Humidity	10 to 90% relative humidity (non-condensing)
Storage Temperature	-40 to 150 °F(-40 to 65.5°C)
Protection Class	IP20

## Compliances

**Table 4: Compliances**

Certificates	CE, FCC, ICES, UL/cUL, RoHs, REACH, California, Title 24, BTL, and Prop65.
Standards	EN 60730-1, EN 60730-2-9, EN 301489-1, EN 301489-17, EN 300328, EN 301893, EN 62479, UL60730-1, UL60730-2-9, Title 47 part 15 subpart B, Title 47 part 15 subpart C, RSS 210, ICES-003

## IO Characteristics

**Table 5: IO Characteristics**

UIO x 2	<ul style="list-style-type: none"> <li>• Resistive Temperature Sensor Input               <ul style="list-style-type: none"> <li>– NTC10K Type II, C7021 series</li> <li>– NTC10K Type III (Space Temperature Sensor only), C7023 series</li> <li>– NTC20K, TR21, and C7041 series</li> </ul> </li> <li>• Temperature Accuracy               <ul style="list-style-type: none"> <li>– <math>\pm 1^{\circ}\text{F}(\pm 0.5^{\circ}\text{C})</math> at 50 to 90 <math>^{\circ}\text{F}(10</math> to 32<math>^{\circ}\text{C})</math></li> <li>– <math>\pm 2^{\circ}\text{F}(\pm 1.1^{\circ}\text{C})</math> at 30 to 122<math>^{\circ}\text{F}(-1.1</math> to 50<math>^{\circ}\text{C})</math></li> </ul> </li> <li>• Voltage Input, SELV               <ul style="list-style-type: none"> <li>– 0-10V, <math>\pm 5\%</math> of full scale</li> </ul> </li> <li>• Digital Input               <ul style="list-style-type: none"> <li>– Dry contact closure</li> <li>– Open circuit (<math>\geq 100\text{Kohms}</math>)</li> <li>– Closed circuit (<math>\leq 100\text{ohms}</math>)</li> </ul> </li> <li>• Voltage Output               <ul style="list-style-type: none"> <li>– 0-10V, <math>\pm 3\%</math> of full scale @2K ohms</li> </ul> </li> </ul>
UI x 2	<ul style="list-style-type: none"> <li>• Resistive Temperature Sensor Input               <ul style="list-style-type: none"> <li>– NTC10K Type II, C7021 series</li> <li>– NTC10K Type III (Space Temperature Sensor only), C7023 series</li> <li>– NTC20K, TR21, and C7041 series</li> </ul> </li> <li>• Temperature Accuracy               <ul style="list-style-type: none"> <li>– <math>\pm 1^{\circ}\text{F}(\pm 0.5^{\circ}\text{C})</math> at 50 to 90 <math>^{\circ}\text{F}(10</math> to 32<math>^{\circ}\text{C})</math></li> <li>– <math>\pm 2^{\circ}\text{F}(\pm 1.1^{\circ}\text{C})</math> at 30 to 122<math>^{\circ}\text{F}(-1.1</math> to 50<math>^{\circ}\text{C})</math></li> </ul> </li> <li>• Voltage Input, SELV               <ul style="list-style-type: none"> <li>– 0-10V, <math>\pm 5\%</math> of full scale</li> </ul> </li> <li>• Digital Input               <ul style="list-style-type: none"> <li>– Dry contact closure</li> <li>– Open circuit (<math>\geq 100\text{Kohms}</math>)</li> <li>– Closed circuit (<math>\leq 100\text{ohms}</math>)</li> </ul> </li> </ul>
DO (G, Y1,Y2,Y3,W1,W2,W3)	<ul style="list-style-type: none"> <li>• Relay Output</li> <li>• Rated Average Current               <ul style="list-style-type: none"> <li>– 1A at 24VAC</li> </ul> </li> <li>• Rated Pulse Current               <ul style="list-style-type: none"> <li>– 3.5A at 24VAC</li> </ul> </li> </ul>
DO (AUX)	<ul style="list-style-type: none"> <li>• Relay Dry Contact</li> <li>• Rated Average Current               <ul style="list-style-type: none"> <li>– 1A at 24VAC/DC</li> </ul> </li> <li>• Rated Pulse Current               <ul style="list-style-type: none"> <li>– 3.5A at 24VAC/DC</li> </ul> </li> </ul>

**Note:** If NTC10K sensors (MA, DA, RA, OA) were configured in firmware 1.00.00.00 or earlier, they will be configured as NTC10K Type II with firmware updates after 1.01.00.00.

## Onboard Sensors

**Table 6: Onboard Sensors**

Temperature	Heat: 40 to 90°F (4.5 to 32°C) Cool: 50 to 99°F (10 to 37°C) Resolution: 1 °F (0.5°C) Control Accuracy: ±1.5°F (0.8°C) at Room Temperature
Humidity	Range: 20~90% RH Resolution: 1%RH Control Accuracy: ±5%RH at Room Temperature and 20~90%RH

## Communication Technologies

**Table 7: Communication Technologies**

BACnet IP	Over Wi-Fi
Wi-Fi	802.11 b/g/n Supported security levels OPEN, WPA, WPA2, WPA3_WPA2_AES
Bluetooth	BLE 4.2 with 1 Mbps Classic Bluetooth with max. 3 Mbps
Sylk™	Honeywell Sylk™
BACnet MS/TP	Over RS485 (9.6, 19.2, 38.4, 76.8, 115.2 Kbps)

## Electrical Characteristics

**Table 8: Electrical Characteristics**

Rated Impulse Voltage	500 V
Construction of Control	Independently Mounted Control
Operation Method	Type 1 Action
Pollution Degree	2
Purpose of Control	Operating Control

## Supported Sensors and Functions

**Table 9: Supported Sensors**

<b>Sensors</b>	<b>Options</b>	<b>Part Numbers</b>
Occupancy Sensor	Direct (Normally Open) Reverse (Normally Closed)	Dry contact occupancy sensor
Dirty Filter Sensor	Direct (Normally Open) Reverse (Normally Closed)	DPS200, DPS400, DPS1000 (Dry contact differential pressure switch)
Proof Of Air Flow Sensor	Direct (Normally Open) Reverse (Normally Closed)	DPS200, DPS400, DPS1000 (Dry contact airflow switch)
Shutdown Sensor	Direct (Normally Open) Reverse (Normally Closed)	Dry contact shutdown switch
Mixed Air Temperature Sensor	NTC 20K NTC 10K Type II NTC 10K Type III Sylk	C7250A, C7041 C7021 C7023 C7400S
Outdoor Air Temperature Sensor	NTC 20K NTC 10K Type II NTC 10K Type III Sylk	C7250A, C7041 C7021 C7023 C7400S
Return Air Temperature Sensor	NTC 20K NTC 10K Type II NTC 10K Type III Sylk	C7250A, C7041 C7021 C7023 C7400S
Discharge Air Temperature Sensor	NTC 20K NTC 10K Type II NTC 10K Type III Sylk	C7250A, C7041 C7021 C7023 C7400S
Space Temperature Sensors	NTC 20K NTC 10K Type II NTC 10K Type III Sylk	TR21, C7041, C7772A, C7021, C7772F, C7023, C7772G TR40, TR40-H, TR40-CO2, TR40-H-CO2 TR120 (max 1)
CO2 sensor	0-10 / 2-10 VDC Sylk	C7233, C7263, C7232 TR40-CO2 TR40-H-CO2
Proof of waterflow	Digital Input	Dry contact waterflow switch
Window Open Sensor	Direct (Normally Open) Reverse (Normally Closed)	Dry contact window open sensor

**Table 9: Supported Sensors**

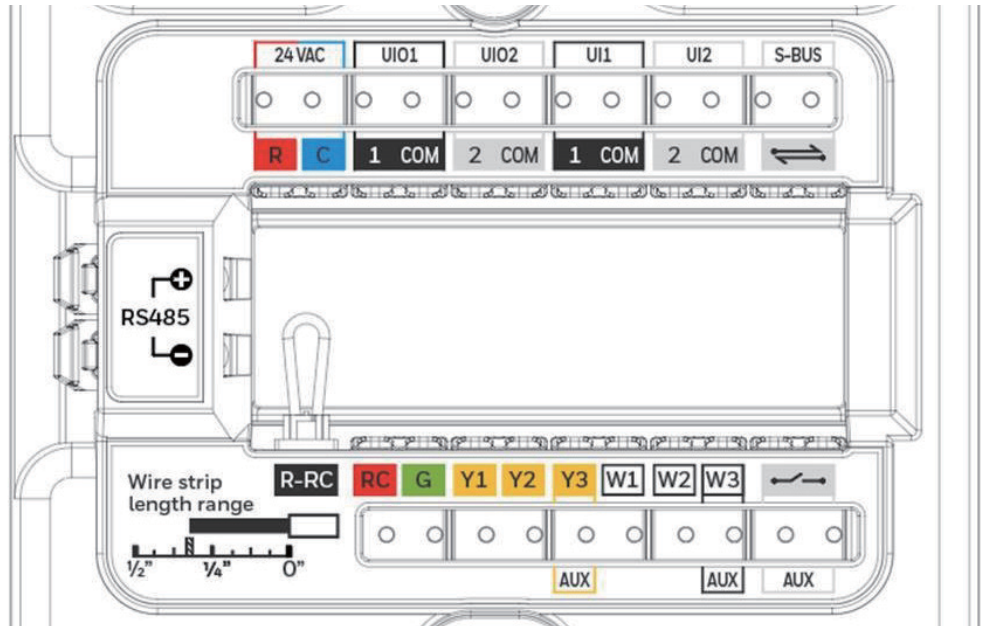
Sensors	Options	Part Numbers
Drain Pan / Leak Detector	Direct (Normally Open) Reverse (Normally Closed)	Dry contact float switch or water sensor

## Part Numbers

**Table 10: Part Numbers**

TC500A-N	Thermostat with North American Wi-Fi conformance
Decoplate-N	TC500 deco plate for NA junction boxes
3011-7144-001	Replacement Backplate for TC500A-N



# Terminal Identification



**Table 11: Terminal Identification**

Terminal	Label	Connection
24VAC	R	24VAC power from heating transformer
	C	24VAC common (Neutral). For 2 transformer systems, use common wire from cooling transformer
UIO1	1	Universal input/output
	COM	Common
UIO2	2	Universal input/output
	COM	Common
UI1	1	Universal input
	COM	Common
UI2	2	Universal input
	COM	Common
Sylk (S-BUS)		Sylk bus, master, power output
		Sylk bus, master, power output
RS485	+	BACnet Communications (BACnet MS/TP A)
	-	BACnet Communications (BACnet MS/TP B)
	R-RC	Jumper between R and RC for single transformer system

**Table 11: Terminal Identification**

Terminal	Label	Connection
24VAC	RC	24VAC power from cooling transformer
	G	Fan
	Y1	Relay output, Compressor contactor (stage1)
	Y2	Relay output, Compressor contactor (stage2)
	Y3	Relay output, Compressor contactor (stage3)/Configurable Output
	W1	Relay output, Heat (stage1)
	W2	Relay output, Heat (stage2)
	W3	Relay output, heat (stage3)/Configurable Output
Aux		Relay dry contact, Aux-1
		Relay dry contact, Aux-2

# Terminal assignment

Table 12: Terminal Assignment

Type	Terminal	Label	Terminal Assignments (Default & Optional Assignments)		
			Default	Inputs	Outputs
Digital Outputs	D01	G	Supply Fan	NA	Fan Command High Speed Fan
	D02	W1	Heat Stage 1		Heating Floating Open
	D03	W2	Heat Stage 2		Heating Floating Closed
	D04	W3 / Aux	NA		Heat Stage 3, Cool/Compressor Stage 4, Reversing Valve OB, Low Speed Fan, Medium Speed Fan, Occupancy, Dehumidification, Humidification, Purge Output, Exhaust Fan 1, Exhaust Fan 2.
	D05	Y1	Cool/ Compress or Stage 1		Cooling Floating Open
	D06	Y2	Cool/ Compress or Stage 2		Cooling Floating Closed
	D07	Y3 / Aux	NA		Cool/Compressor Stage 3, External Economizer, Low Speed Fan, Medium Speed Fan, Occupancy, Dehumidification, Humidification, Purge Output, Exhaust Fan 1, Exhaust Fan 2.
	D08 (Dry Contact, 2 terminals)	Aux			Cool/Compressor Stage 4, External Economizer, Low Speed Fan, Medium Speed Fan, Occupancy, Dehumidification, Humidification, Purge Output, Exhaust Fan 1, Exhaust Fan 2.



Table 12: Terminal Assignment

Type	Terminal	Label	Terminal Assignments (Default & Optional Assignments)		
			Default	Inputs	Outputs
Universal Inputs	UI1 (2 terminals)	UI1	NA	CO2 Sensor Input, Dirty Filter, Discharge Air Sensor, Drain Pan Sensor, External Economizer Fault, Mixed Air Sensor, Occupancy Sensor, Outdoor Air Sensor, Proof of Airflow, Proof of Waterflow, Return Air Sensor, Shutdown, Space Temperature Sensor, Window Open Sensor.	
	UI2 (2 terminals)	UI2	NA		
Universal Inputs/ Outputs	UIO1 (2 terminals)	UIO1	NA		CO2 Output, Fan Speed Control, Modulating Cool, Modulating Heat, Purge Output.
	UIO2 (2 terminals)	UIO2	NA		
Power	R	R		24v Power	
	C	C		Common	
	RC	RC		24v Power / Cooling	
Sylk Bus	1	S-Bus		Sylk connection	Selectable type pre-defined by Sylk address number
	2				

# Security requirement

## System Environmental Considerations

An Internet firewall is required to isolate the Thermostat. Unprotected Internet connections can expose and damage the thermostat system and facility components to cyber-attacks from third parties. This may cause the thermostat to malfunction and can also be misused for illegal purposes for which the operator may then be held liable.

## Deployments and Maintenance Considerations

- Always keep the local server up to date on the latest security patches via a regular system update. This applies not only to workstations or servers running on Windows, Linux, Mac, or any devices that run as part of information infrastructure or operations workstation.
- Always keep the thermostat firmware with the latest released firmware to have maximum protection by built-in security features.
- Do not use default passwords for any devices (if exists). This includes, but not limited, to all server workstations, storage servers, firewall devices, routers, and mobile devices.
- Do not use weak passwords for server administrators or operators. Different user roles (for example administrator, user, guest, etc.) shall have a different password, and the user should not share common passwords.
- In case of wireless communication, malicious wireless devices can easily scan the wireless channel and inject malicious packets or mass data flow to perform Denial-of-Service attacks. Honeywell has taken steps to prevent the TC500A Commercial Thermostat device from being injected, but the mass data flow will result in the loss of wireless communication bandwidth within the whole system. A regular check of the communication failure rate or response rate of the thermostat is helpful to discover and isolate devices being attacked and stop the physical attacks in the daily operation

## Network Communication Notice

- To keep maximum integration compatibility with third-party devices and Fast-pack communications are un-encrypted as open protocol. Improper security protection may lead to data leakage, spoofing, and/or tampered by malicious devices and denial-of-service attacks.
- To keep maximum integration compatibility with legacy devices, in-room wired devices are less secure from data confidentiality and authentication thus not-recommended for a new design. It is always highly recommended to use deep mesh wireless network communication to gain maximum protection and the latest updates.
- In case of Denial-of-Service attacks, all communication channels will inevitably have a loss of bandwidth due to malicious data flow.
- Connected devices may contain legacy technology, which is less secure under modern cyber-security attacks. Honeywell strongly recommends using a secured deep mesh wireless network communication. In case of legacy technology, the user needs to be aware of the risk of being tampered with or attacked. To reduce the attack surface, the user is advised to physically secure the wired communication signals or provide necessary shield on wires, or place necessary access control on accessing such communication wires.

## Getting started

This chapter describes the TC500A Thermostat display, home pages, icons, device registration, and other user interfaces. For mounting the TC500A Thermostat, refer to TC500A Thermostat Mounting instructions (31-00399M).

### Related topics

[Thermostat display overview](#)

[Presence detection](#)

[Home Page: Temperature reading and adjustment](#)

[Quick access page \(right side page\): Device configuration](#)

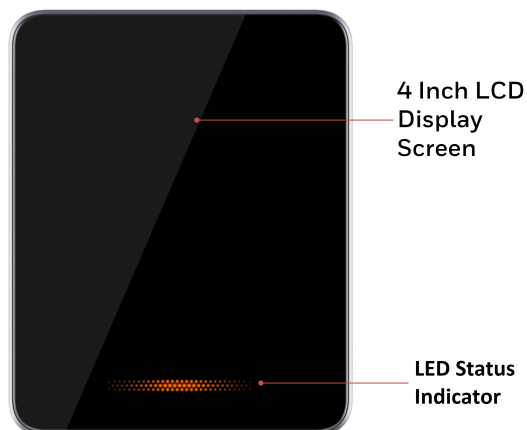
[Ambiance page \(left side page\): Sensor reading](#)

[Home screen icon overview](#)

[Smart LED indication](#)

## Thermostat display overview

The image below illustrates the typical screen of TC500A Thermostat screens in sleep mode. The 4 inch LCD screen on the thermostat is touch-sensitive and shows the status of the thermostat.



## Presence detection

TC500A Thermostat has a built-in proximity sensor. It detects the presence of a user up to 1.5 meters, and “wakes” the screen to prepare for user interaction.

## Home Page: Temperature reading and adjustment

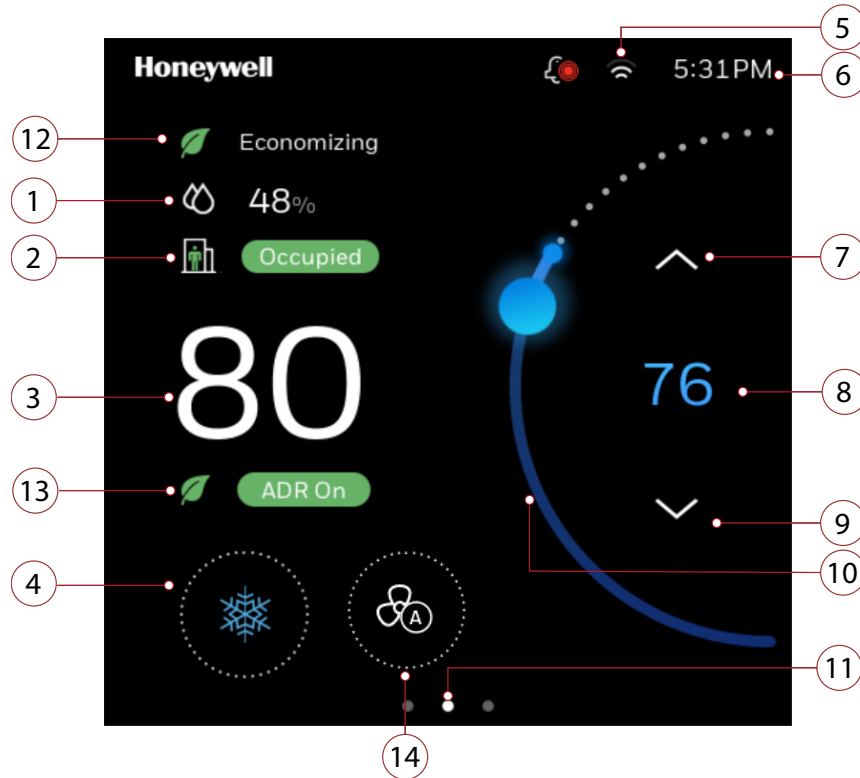


Table 13: Home Page (main screen) Overview

Item	Description
1	<b>Indoor Humidity:</b> Displays the current indoor humidity
2	<b>Current Mode:</b> Indicates the current Setpoint Status (Occupied, Unoccupied, Standby, Temporary)
3	<b>Indoor Temperature:</b> Displays the current indoor temperature.
4	<b>Mode Display:</b> Orange flame for heat mode, blue snowflake for cool mode.
5	Wi-Fi signal strength
6	Time
7	<b>Adjust temperature:</b> Touch the up arrow to increase the desired temperature.
8	<b>Desired temperature:</b> Displays the desired temperature.
9	<b>Adjust temperature:</b> Touch the down arrow to decrease the desired temperature.
10	<b>Temperature Slider:</b> Use a finger to move the slider to set the desired temperature.
11	<b>Home screen indicator:</b> Use finger to swipe to left or right to display more options.
12	<b>Energy saving (Green leaf icon):</b> Energy saving controls such as economizing is active. If purge is in progress, then purge icon will replace energy saving icon. Refer to <a href="#">Home screen icon overview</a>

Table 13: Home Page (main screen) Overview

Item	Description
13	<b>ADR:</b> Tap to view or opt out from Auto Demand Response events.
14	<b>Fan Speed:</b> Indicates current Fan speed for Fan Coil unit. Tap to change the fan speed.

## Quick access page (right side page): Device configuration

Swipe left from the home page to view the Quick access page.

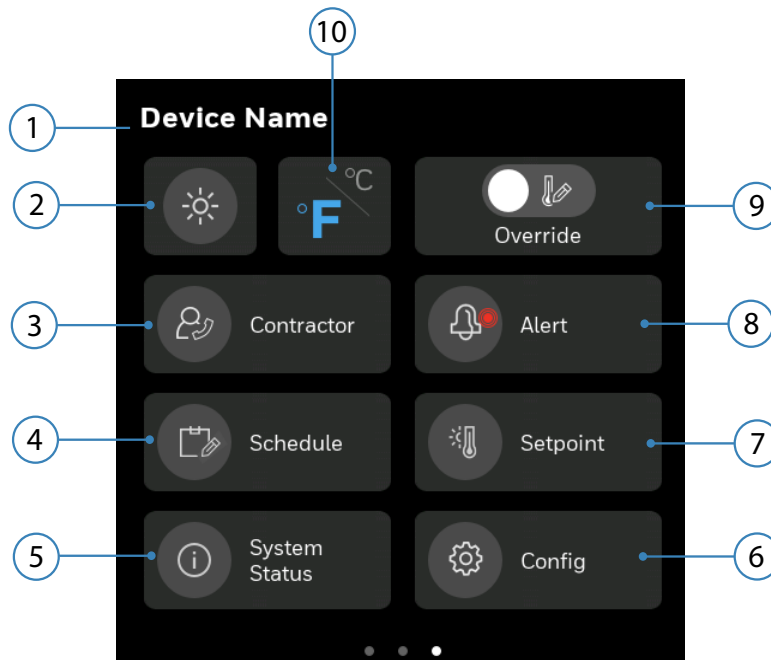
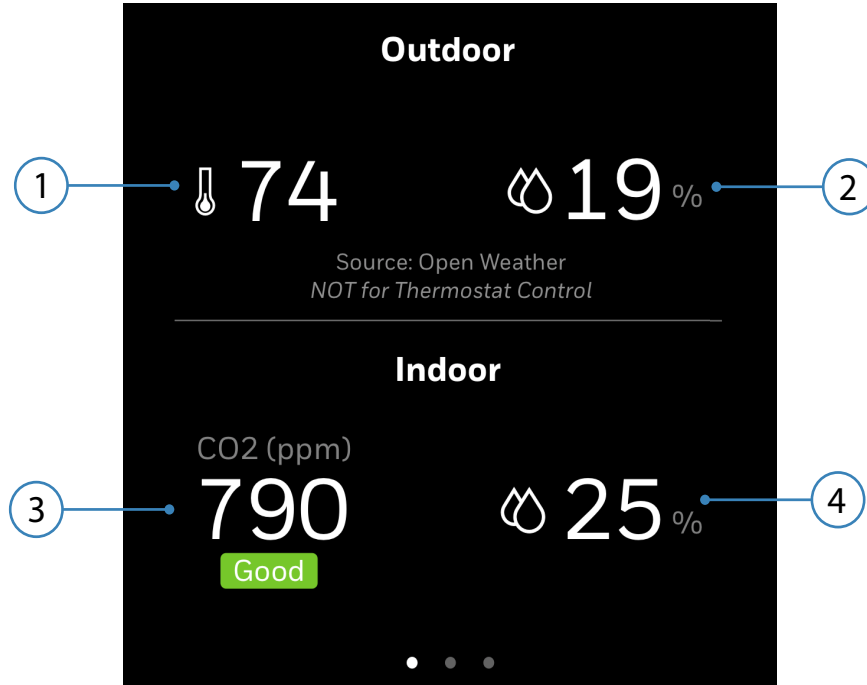


Table 14: Quick access page

Item	Description
1	The name assigned to the thermostat while performing initial set up.
2	<b>Brightness:</b> Increase or decrease the brightness of the display.
3	<b>Contractor information:</b> View contractor information.
4	<b>Schedule:</b> Set the schedules.
5	<b>System Status:</b> See the system status of various equipment (moved from Config menu)
6	<b>Config:</b> Configure the thermostat.
7	<b>Setpoint:</b> Configure the set points of various parameters.
8	<b>Alerts:</b> View active alarms.
9	<b>Override:</b> Override unoccupied or standby modes to allow setpoint adjustments.
10	<b>Temperature Units:</b> Toggle between Fahrenheit or Celsius.

## Ambiance page (left side page): Sensor reading

Swipe right from the home page to view the Ambiance page. Establish Internet connection with thermostat, setup the location or connect to outdoor sensors to display the humidity and outdoor temperature. See [Initial Configuration](#).


















**Note:** The types of reading displayed varies according to the sensor connected to the thermostat.

Table 15: Typical ambiance page

Item	Description
1	Outdoor temperature
2	Outdoor humidity
3	Indoor CO2 level
4	Indoor humidity

# Home screen icon overview

Table 16: Home Screen Icon Overview

Icon	Description
	High severity alert
	Medium severity alert
	Low severity alert
	Auto mode
	Emergency heat mode
	Heating mode
	Cooling mode
	Occupied mode
	Standby mode
	Unoccupied mode
	Temporary mode
	Wi-Fi signal strength
	Purge
	Energy saving (Economizing/ADR)
	Fan speed of the fan coil unit



# Smart LED indication

Table 17: Smart LED Indication





Display	Stages	LED, screen status and Description
		Interact with touchscreen <ul style="list-style-type: none"> <li>• Screen ON</li> <li>• LED Lighting OFF</li> </ul>
	Heating	The orange light pulses when in heating and auto heat mode <ul style="list-style-type: none"> <li>• Screen OFF</li> <li>• LED Lighting ON (Light stops pulsing when the indoor temperature reaches the setpoint)</li> </ul>
	Cooling	The blue light pulses when in cooling and auto cool mode <ul style="list-style-type: none"> <li>• Screen OFF</li> <li>• LED Lighting ON (Light stops pulsing when the indoor temperature reaches the setpoint)</li> </ul>

Table 17: Smart LED Indication

Display	Stages	LED, screen status and Description
	Off	<ul style="list-style-type: none"><li>• Screen OFF</li><li>• LED lighting OFF</li></ul>

# Initial Configuration

This chapter contains steps and descriptions to set up the initial configuration of the thermostat and other basic configurations.

## Related topics

[Prerequisites](#)

[WARNINGS](#)

[Boot-up the thermostat](#)

[Honeywell Connect Mobile App](#)

[Integrating with Occupant app and Cloud registration](#)

## Prerequisites

Before going through initial guided setup sequences, ensure the TC500A is installed and wired up according to the TC500A installation and mounting guide.

## WARNINGS

- To reduce the risk of electrical shock do not open the thermostat. There are no user-serviceable parts inside. Refer servicing to qualified service personnel only.
- Cleaning — Use a dry cloth to clean the product. Do not use liquid cleaners or aerosol cleaners
- Water and moisture — Do not use the product near water. Do not install the product in a place where water may splash onto it.
- Do not operate the thermostat with a hard, sharp, or pointed object such as a fingernail, pen.
- The screen used for the thermostat is made of glass. Therefore, it can break when the product is dropped or heavy impact is applied. Be careful not to be injured by broken glass pieces in case the screen breaks.

## Boot-up the thermostat

The thermostat will be powered up automatically after it mounted on the wallplate. You will navigate through the settings given below subsequently while setting up the thermostat.

- [Configuring the language](#)
- [Configuring the thermostat via mobile app](#)
- [Configuring the thermostat via local interface](#)
- [Assigning a name to the thermostat](#)
- [Selecting a temperature unit](#)
- [Setting Date and Time](#)
- [Setting up the Equipment type](#)
- [Setting up the conventional equipment](#)
- [Setting up the Heat pump](#)
- [Setting up the Fan coil unit](#)
- [Configuring the Setpoints](#)
- [Setting up the Installer Passcode](#)
- [Configuring the contractor information](#)
- [Connecting the thermostat to Wi-Fi](#)

### To set up the thermostat

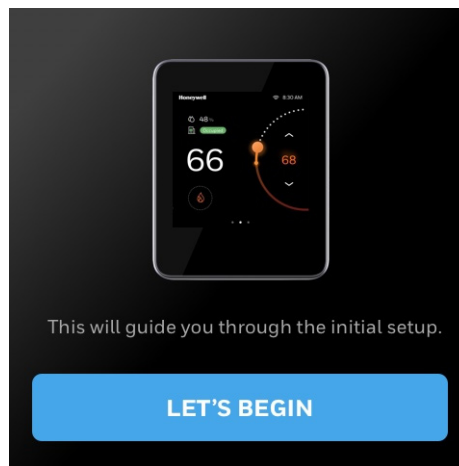
1. Boot-up the thermostat.  
The Honeywell logo page appears, followed by the “Welcome to TC500A” page.

**Figure 3** Welcome screens



The Welcome page followed by the LET'S BEGIN page appears.

Figure 4 Welcome screen

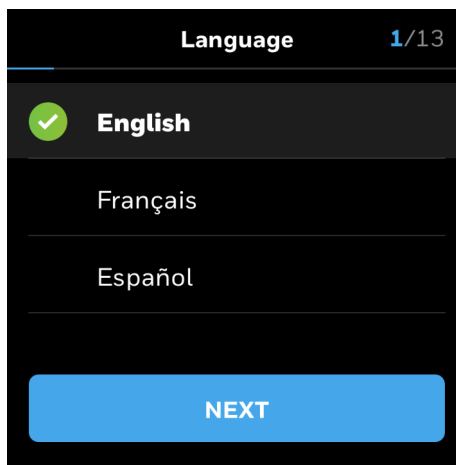


2. Tap **LET's BEGIN**.  
The Language page appears.

### Configuring the language

**Note:** French and Spanish language support is coming soon.

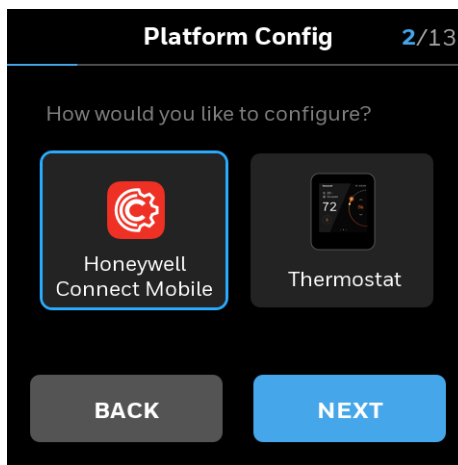
Figure 5 Language page



The Platform Configuration page appears.  
The Platform Configuration page allows to configure the thermostat using mobile app or thermostat interface locally.

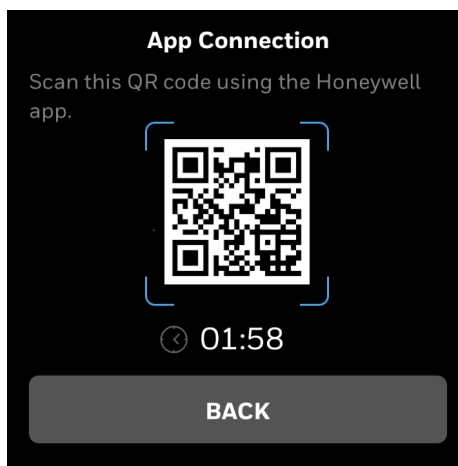
### Configuring the thermostat via mobile app

Figure 6 Platform Configuration



3. To configure using mobile app, tap **Honeywell Connect Mobile**, and tap **NEXT**. A QR code displays on the thermostat screen. For more information, see [Honeywell Connect Mobile App](#).

Figure 7 QR Code screen



4. Download and install the Honeywell Connect Mobile app from Play Store or App Store.

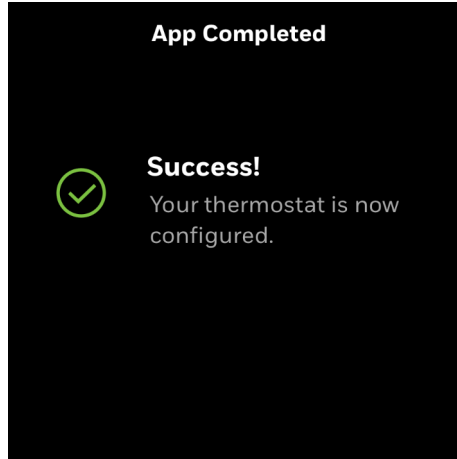


5. Scan the QR code by aligning the QR code on the Honeywell Connect Mobile app within the frame on your mobile phone camera screen.
6. The thermostat will be connected to the mobile application.
7. Follow the set up guide on mobile application to complete the configuration. See [Honeywell Connect Mobile App](#).

**Note:** *During the User Registration process, you will be assigned an email ending with @honeywellcloud.com. Please make note of this user email, as it will be required for future sign in.*

8. After setup is completed, the App Completed message appears.

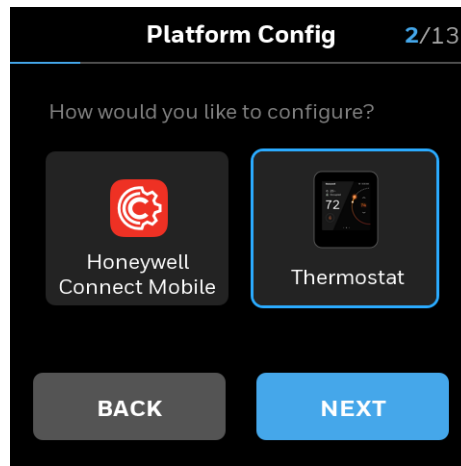
Figure 8 Mobile app configuration successful message



### Configuring the thermostat via local interface

9. On the platform configuration screen tap **Thermostat**, and tap **NEXT**.

Figure 9 Platform configuration (Thermostat)

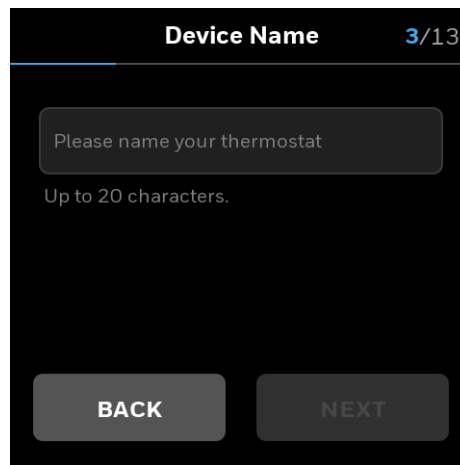


The **Device Name** page appears.



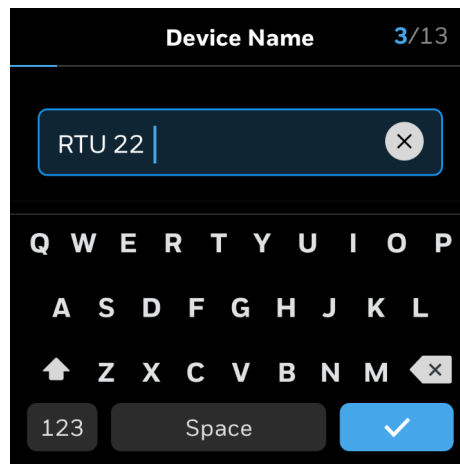
## Assigning a name to the thermostat

Figure 10 Device Name



10. Tap on the text field  
A keyboard will be displayed on the screen to enter the device name.
11. Enter the device name.  
Assign a unique name to a thermostat specifying a name to the location where the thermostat is installed. It assists the user to easily identify the device during remote operation of the thermostat.

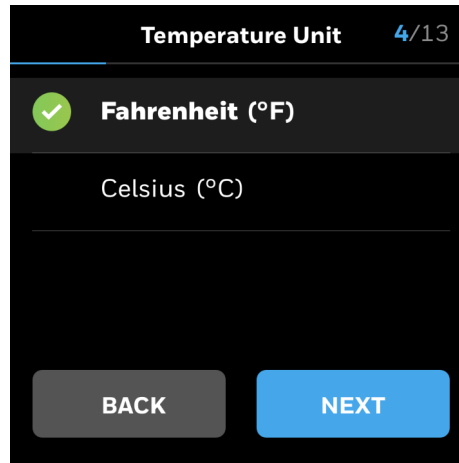
Figure 11 Saving the device name



12. After entering a valid device name tap **NEXT**.  
The device name is saved and the Temperature Unit page appears.

### Selecting a temperature unit

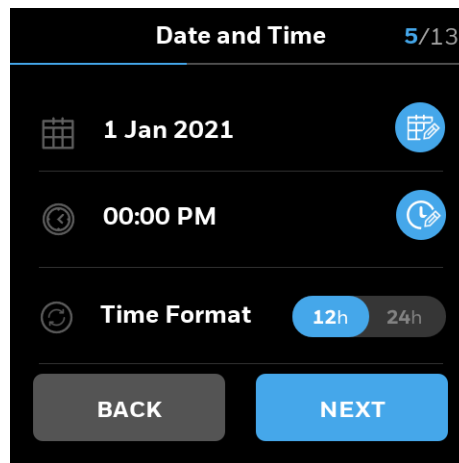
Figure 12 Temperature unit



13. Select a preferred temperature unit and tap **NEXT**.  
The Date and Time page appears.

### Setting Date and Time

Figure 13 Date and Time Config page

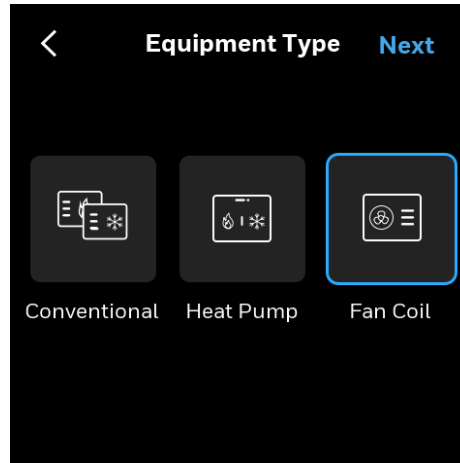


14. Tap the calendar pen icon to set the date.
15. Tap the clock icon to set the time.
16. Slide the Display toggle button to the right to set the 24h time format if required.
17. After setting date and time, tap **NEXT**.  
The Equipment Type page appears.

## Setting up the Equipment type

The TC500A is designed to control Heat Pump, Conventional HVAC, or Fan coil units. It can control up to 3 heating stages and 4 cooling stages in conventional systems and up to 3 compressor stages and 2 auxiliary heat stages in heat pump systems. In Fan coil, 2-pipe heat or cool only Single coil, or a 4-pipe Dual coil can be configured.

**Figure 14** Equipment type - Conventional



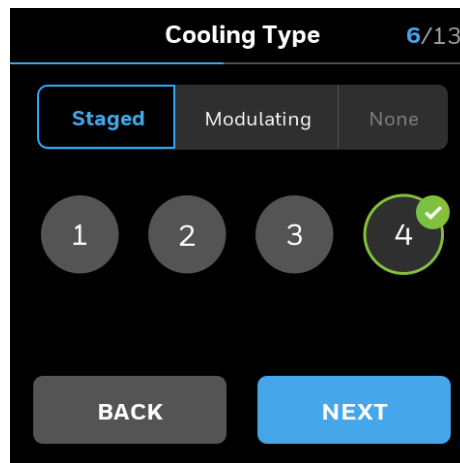
## Setting up the conventional equipment

Notes: To configure the Heat pump, refer to the [Setting up the Heat pump](#) section. Skip setting up the conventional equipment section.

To configure the Fan coil, refer to the [Setting up the Fan coil unit](#) section.

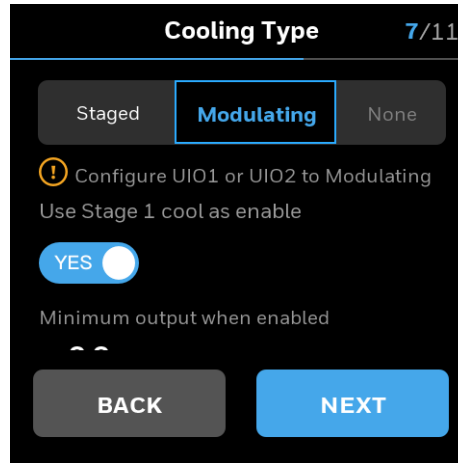
18. On the Equipment Type page, tap **Conventional** and tap **NEXT**.  
The Cooling Type page appears.

**Figure 15** Cooling stages



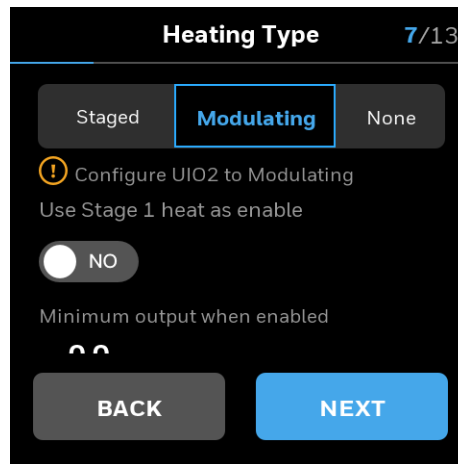
19. Under the Staged tab, select a required number of cooling stages.
20. To use the modulating cool type, tap **Modulating**.  
The Modulating page appears.

Figure 16 Cooling type - Modulating



21. Toggle the **Use stage 1 cool as an enable** button to **YES**, if system requires an enable signal.
22. Swipe the slider to select the desired minimum voltage output when cooling is active.
23. If no cooling is required, tap **None**.
24. After setting up cooling stages, tap **NEXT**.  
The Heating Type page appears.
25. Under the Staged tab, select a required number of heating stage.
26. To use the modulating heat type, tap **Modulating**.

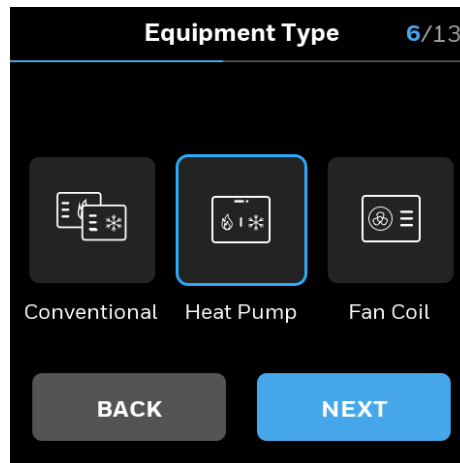
Figure 17 Modulating heating



27. Toggle the **Use stage 1 heat as an enable** button to **YES**, if system requires an enable signal.
28. Swipe the slider to select the desired minimum voltage output when heating is active.
29. If no heating is required, tap **None**.
30. After setting up heating stages, tap **NEXT**.  
The Setpoints page appears. Refer to [Configuring the Setpoints](#).

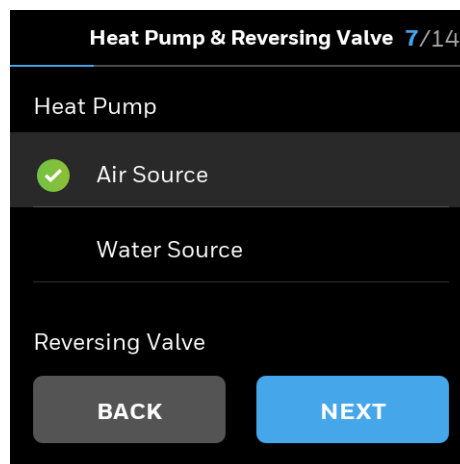
## Setting up the Heat pump

Figure 18 Heat pump



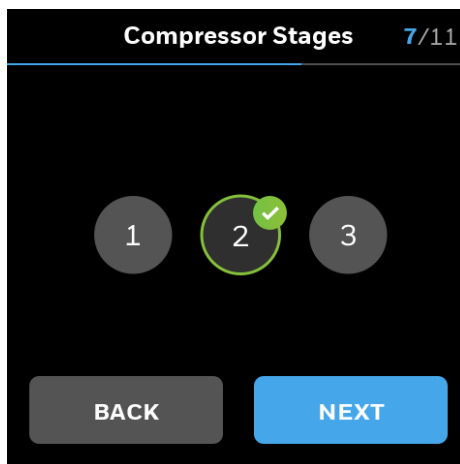
31. On the Equipment Type page, tap **Heat pump** and tap **NEXT**.  
The **Heat Pump** and **Reversing Valve** page appears.

Figure 19 Type of Heat Pump and Reversing Valve



32. Tap **Air Source** or **Water Source** and tap **NEXT**.  
The Compressor Stages page appears.

Figure 20 Compressor stages of heat pump

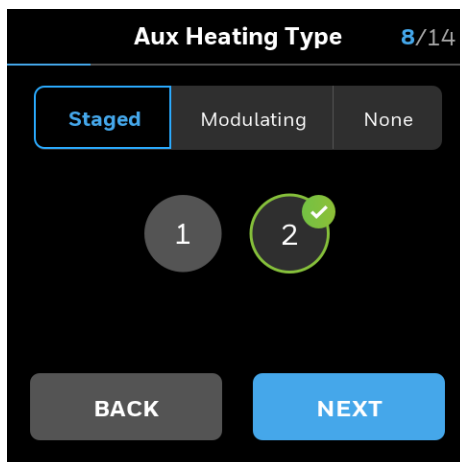


33. Select a required compressor stage number.

34. Tap **NEXT**.

The Aux Heating Type page appears.

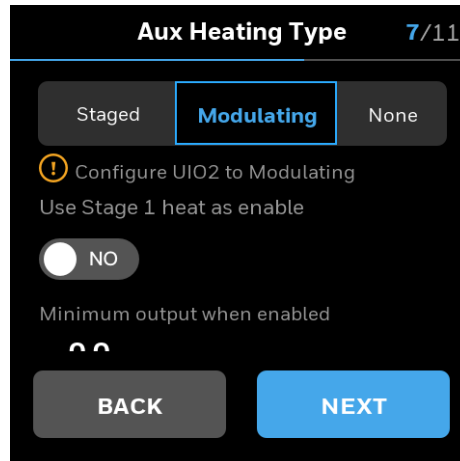
Figure 21 Aux Heating Type



35. Under the Staged tab, select a required number of heating stage.

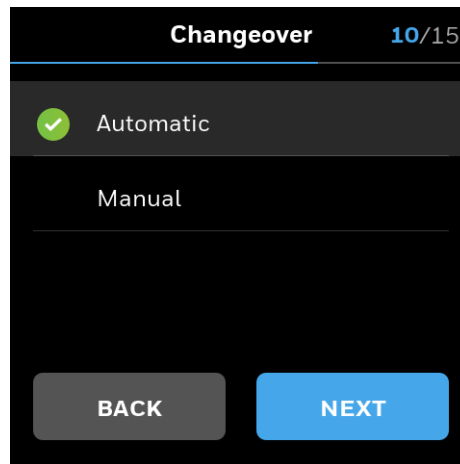
36. To use the modulating heat type, tap **Modulating**.

Figure 22 Modulating heating



37. Toggle the **Use stage 1 heat as an enable** button to **YES**, if system requires an enable signal.
38. Swipe the slider to select the desired minimum voltage output when heating is active.
39. If no heating is required, tap **None**.
40. After setting up heating stages, tap **NEXT**.  
The Changeover page appears.

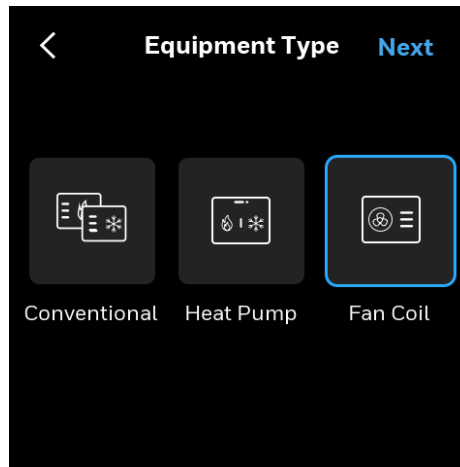
Figure 23 Changeover page



41. Select a changeover mode and tap **NEXT**.  
The Setpoints page appears. Refer to [Configuring the Setpoints](#).

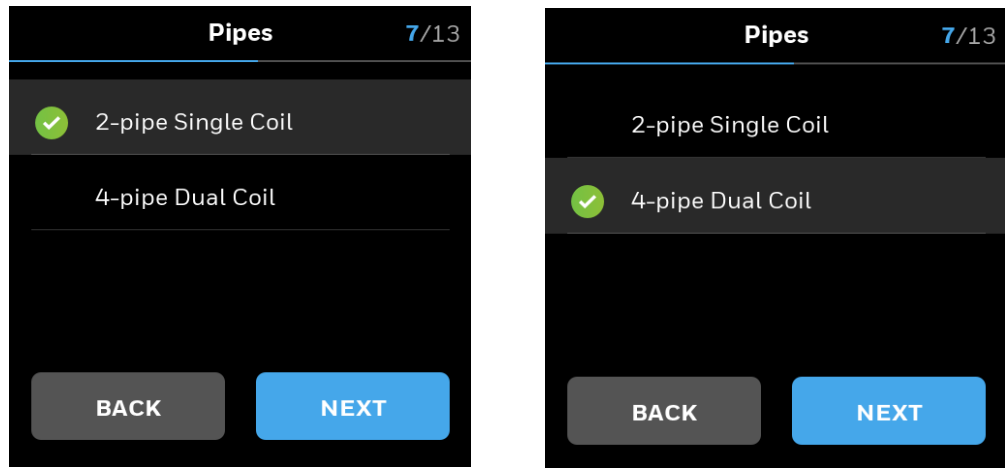
### Setting up the Fan coil unit

Figure 24 Fan coil



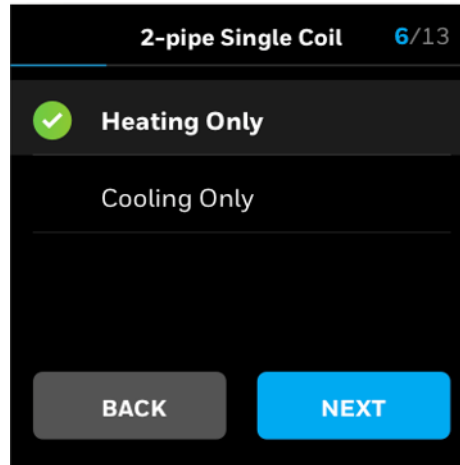
42. On the Equipment Type page, tap **Fan Coil** and tap **NEXT**.  
The Pipes page appears.

Figure 25 Fan coil - Pipes



43. Tap **2-pipe Single Coil** or **4-pipe Dual Coil** based on the actual fan coil installed on the field.
44. Tap **NEXT**.  
If 2-pipe Single Coil was selected, 2-pipe Single Coil options appear. If 4-pipe Dual Coil was selected, skip to step 46.



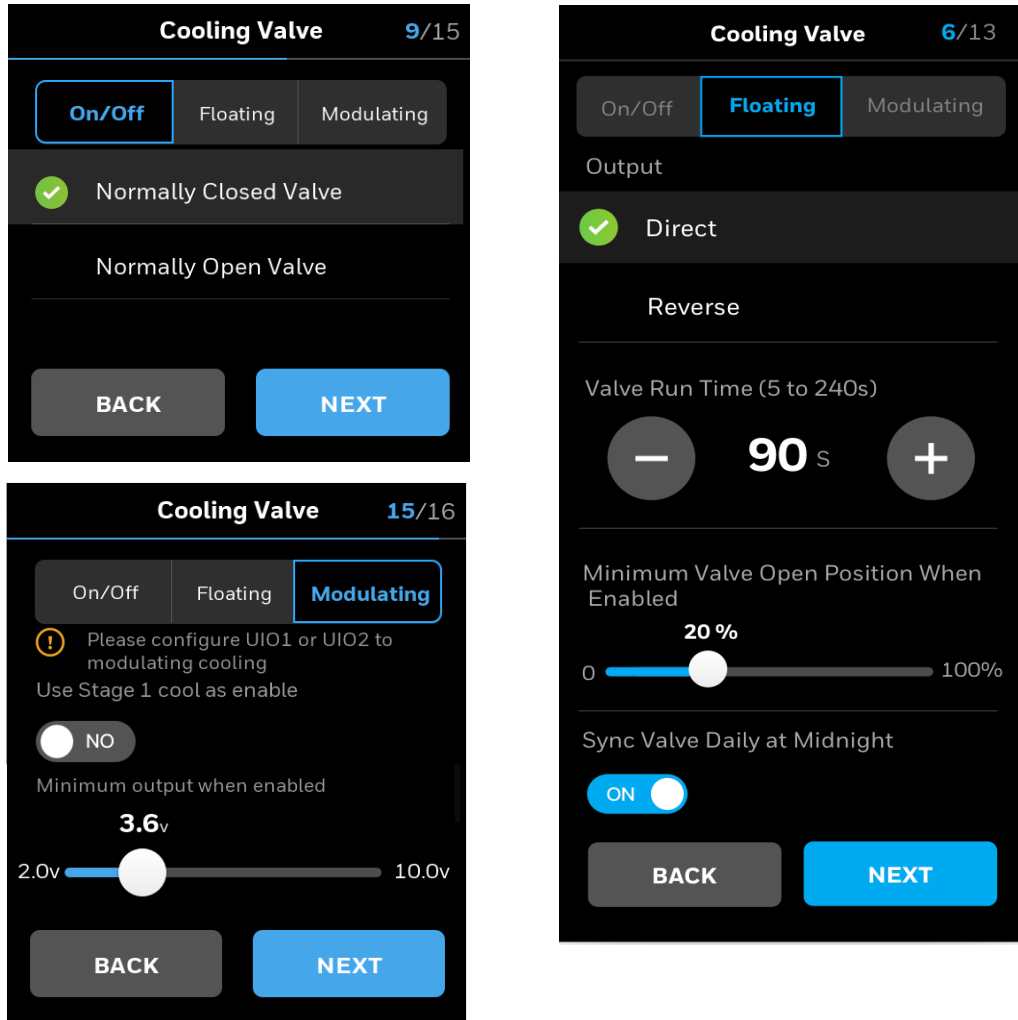
**Figure 26** 2-pipe Single coil options

45. Tap **Heating Only** for heating unit or tap **Cooling Only** for cooling unit.

46. Tap **NEXT**.

Based on the selection, Heating Valve and/or Cooling Valve page appears. Both pages have same options.

Figure 27 Cooling valve options



User can select On/Off, Floating, or Modulating valve type. Whatever cooling valve type is selected, the same will be applied to the heating valve type and vice-versa.

**On/Off**

If the valve type is **On/Off**, select **Normally Closed Valve** or **Normally Open Valve**.

**Floating**

If the valve type is **Floating**, then floating related options appear.

**Modulating**

If the valve type is **Modulating**, set the required values.

**Use Stage 1 cool as Enable / Use Stage 1 heat as Enable:** When set to YES, will also energize the W1 or Y1 terminal when there is an active call for heating or cooling. This can be used to send a demand call to a zone system, energize a circulation pump or energize a perimeter heat valve.

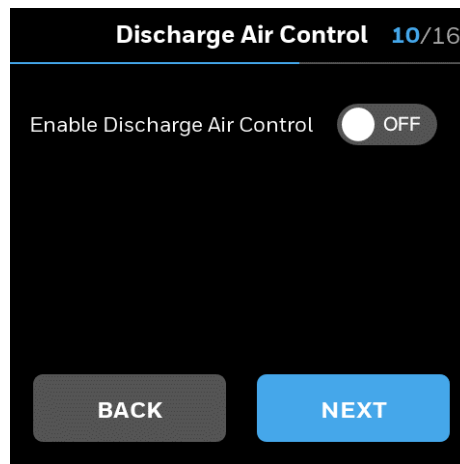
**Minimum Output When Enabled:** Setting is used to adjust the minimum voltage to the valve when there is an active call for heating or cooling. This setting can be used to set

the minimum position on a control valve or minimum load on a variable speed compressor. Minimum Output when Enabled will function as Maximum output when enabled if Control Action is set to Reverse Acting. Control Action, Min. Output, Max. Output settings can be adjusted in the Configurable I/O menu under the assigned UIO terminal.

47. Tap **NEXT**.

If the valve position is selected as Floating or Modulating, then the Discharge Air Control page appears. This is not applicable for the On/Off valve position.

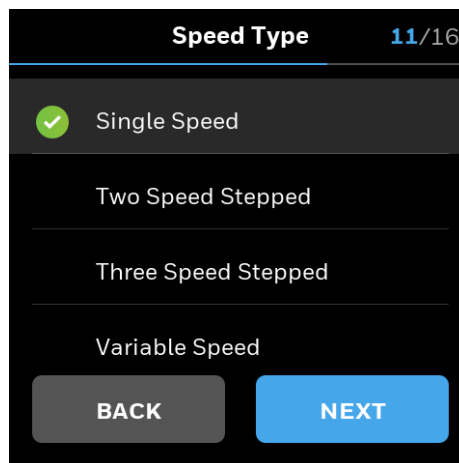
**Figure 28** Discharge air control



48. Tap **NEXT**.

The Fan Type page appears.

**Figure 29** Fan type page

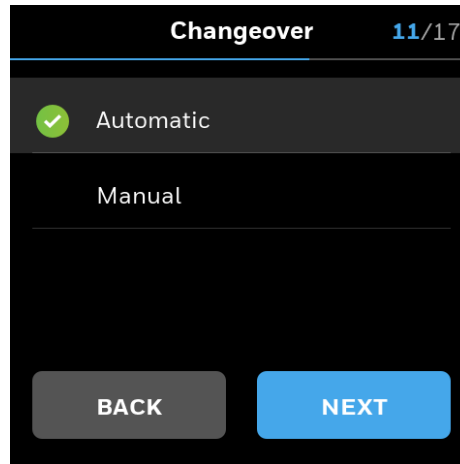


49. Tap a fan speed type.

50. Tap **NEXT**.

If the selected coil type is 4-pipe dual coil, then the Changeover page appears.

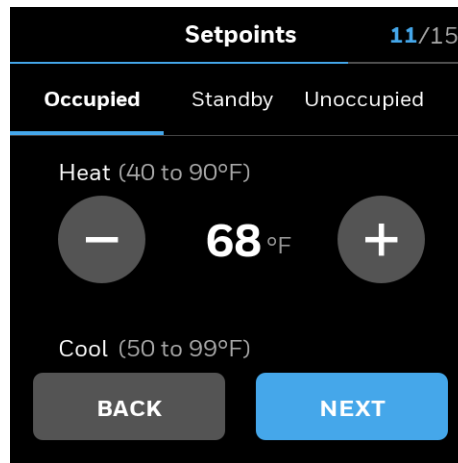
Figure 30 Changeover for 4-pipe dual coil



51. Tap **Automatic** or **Manual**.
52. Tap **NEXT**.  
The Setpoints page appears.

### Configuring the Setpoints

Figure 31 Define the setpoints



**Tip:** Long press the +/- button to quickly increase or decrease the value.

53. Configure the required setpoint limits for Occupied, Standby, and Unoccupied modes. Thermostat performs limit checking on all temperature setpoints, in case setpoint relationships are violated.
  - Occupied mode treats the building space as occupied and configured with comfort setpoints.
  - Unoccupied mode treats the building space as not occupied and configured with energy savings setpoints.
  - Standby mode setpoints are configured in a way that the setpoints can quickly change to the Occupied mode when switched. Standby mode setpoint saves energy higher than occupied mode and lesser than the Unoccupied mode.
  - Temporary mode allows the user to change the temperature setpoints of the Occupied mode after the user switches to the temporary mode from the Occupied mode. This is not possible in Unoccupied mode and Standby mode.

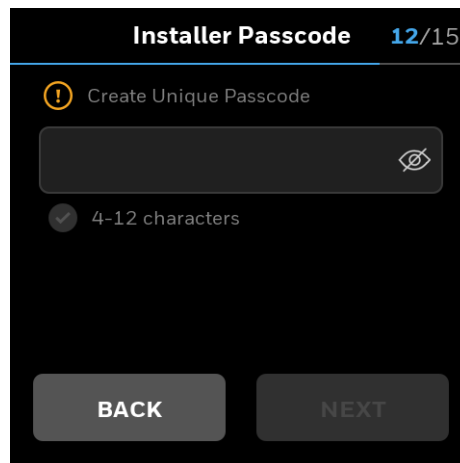
- When a schedule uses the Occupied mode but the Occupancy sensor reads occupied, then the effective state is Occupied. When a schedule uses Occupied mode, and the Occupancy sensor detects Unoccupied, the effective mode will change to Standby. When the scheduled occupancy state is Unoccupied or Standby, the effective occupancy will follow scheduled occupancy state and will ignore the occupancy sensor's value.
- Minimum cool setpoint and maximum heat setpoint can be adjusted, default minimum cool setpoint is 50°F, maximum heat setpoint is 90°F. Heat setpoint range: 40°F-90°F; Cool setpoint range: 50°F-99°F.
- While configuring the temperature range make sure that the unoccupied heat <= standby heat <= occupied heat < occupied cool <= standby cool <= unoccupied cool.
- Occupied cool setpoint should be at least a deadband value bigger than occupied heat setpoint.
- The occupancy sensor only affects the effective occupancy when the scheduled occupancy state is Occupied:
- When occupancy sensor state is occupied, the effective occupancy will act as occupied.
- When occupancy sensor state is unoccupied, the effective occupancy will change to standby.
- When the scheduled occupancy state is unoccupied or standby, the effective occupancy will follow scheduled occupancy state, will ignore the occupancy sensor's value.

54. Tap **NEXT**.

The Installer Passcode page appears.

## Setting up the Installer Passcode

Figure 32 Setting Installer Pin



55. Tap on the text field  
A keyboard will popup.

56. Enter a passcode.

**Note:** The passcode must contains 4 to 12 characters including a Alpha/numeric/symbol character.

**Tip:** Tap the Eye icon to view and confirm the Passcode. Make note of the Passcode for future reference.

57. Tap the tick button.

58. Tap **NEXT**.

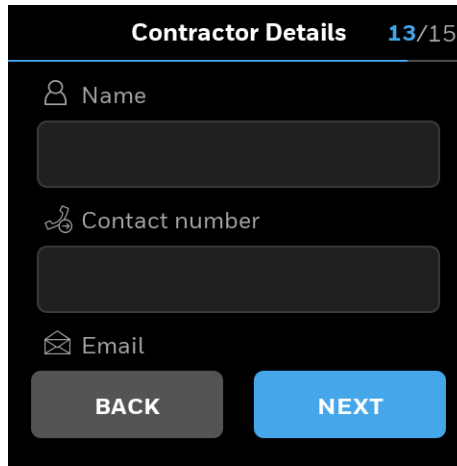
The Contractor Information page appears.

**Note:** The Installer passcode is to prevent unauthorized changes to thermostat settings.

This passcode will be needed to enter into locked menu's, such as Advanced Configuration.

### Configuring the contractor information

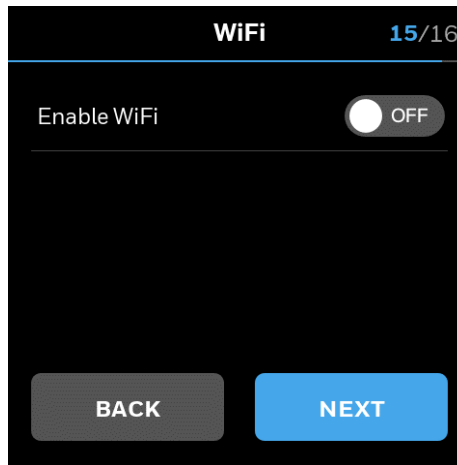
Figure 33 Contractor Information



- 59. Enter the contractor information.
- 60. Tap **NEXT**.  
The Wi-Fi page appears.

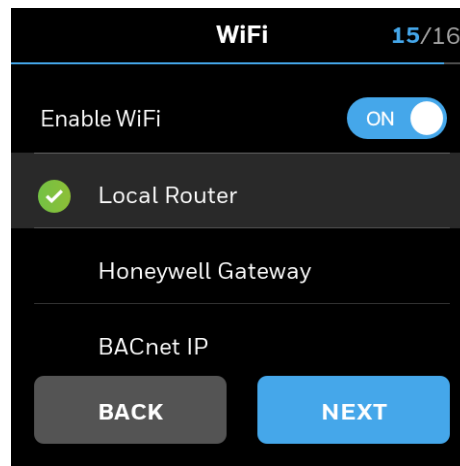
### Connecting the thermostat to Wi-Fi

Figure 34 Connection request page



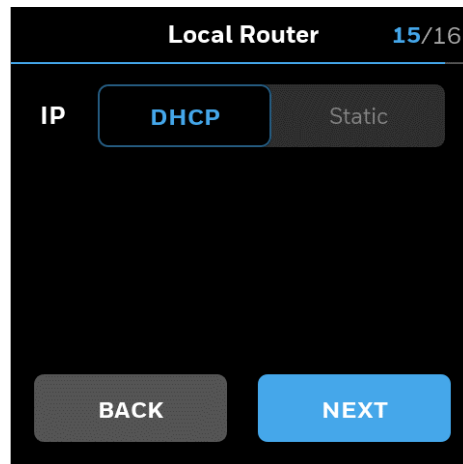
- 61. Slide the **Enable WiFi** button to **ON**.
- 62. Select a type of connection.  
Local Router: Select this option to directly connect the thermostat to cloud.  
Honeywell Gateway: Select this option to connect the thermostat to gateway system.  
BACnet IP: Select this option to connect the thermostat to BACnet device.

Figure 35 Wi-Fi page



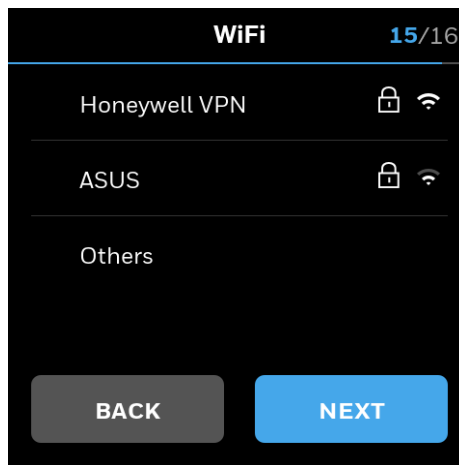
63. Tap **Local Router**.  
The Local Router page appears.

Figure 36 Local router



64. Tap **DHCP** for automatic assigning of the IP address or tap **Static** to manually enter the IP address and Subnet Mask.
65. Tap **NEXT**  
A list of Wi-Fi connections appear.

Figure 37 Local Router - Wi-Fi connections



66. Tap a Wi-Fi connection.

67. Tap **NEXT**.

68. Enter the Wi-Fi connection password.

69. Tap the tick button.

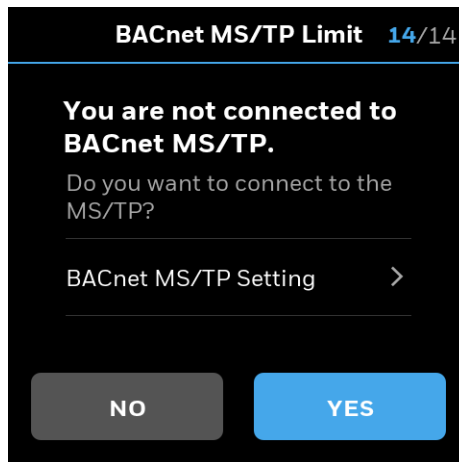
70. Tap **NEXT**.

Wi-Fi connection loading page appears.

If the connection is successful, “Your thermostat is now connected” message appears.

71. Tap the screen, BACnet MS/TP Limit page appears.

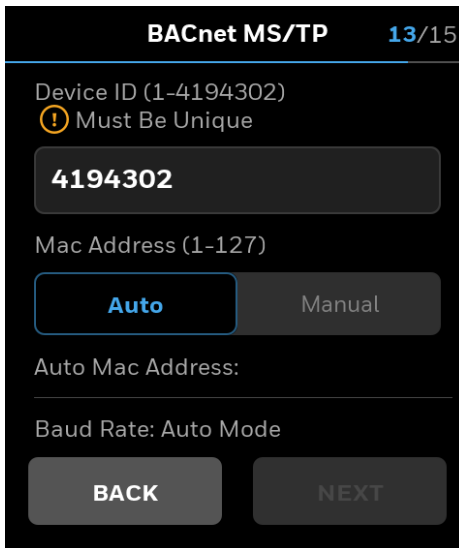
Figure 38 BACnet MS/TP connection



72. Tap **YES** to connect BACnet MS/TP, or tap **NO** to continue without BACnet MS/TP

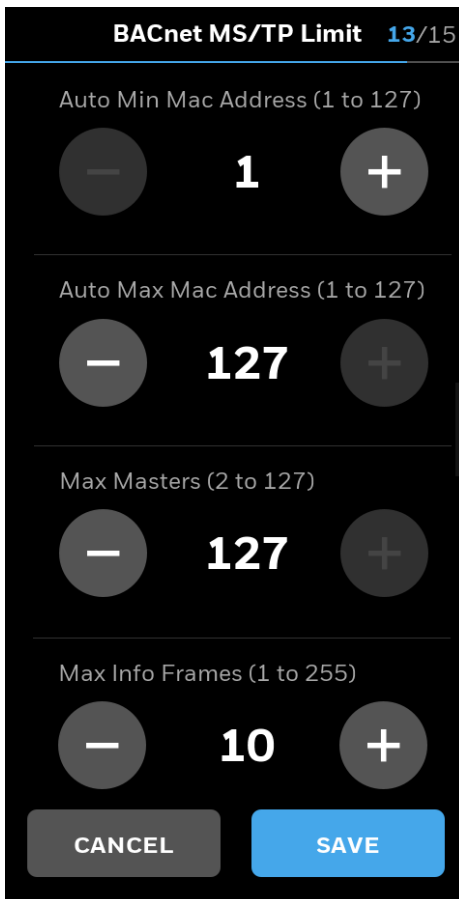


Figure 39 BACnet MS/TP settings



- 73. Enter a unique Device ID for the thermostat. It should be different from other TC500A thermostats.
- 74. Auto-MAC addressing is enabled by default, Installer can also manually set a unique MAC address for the TC500A.

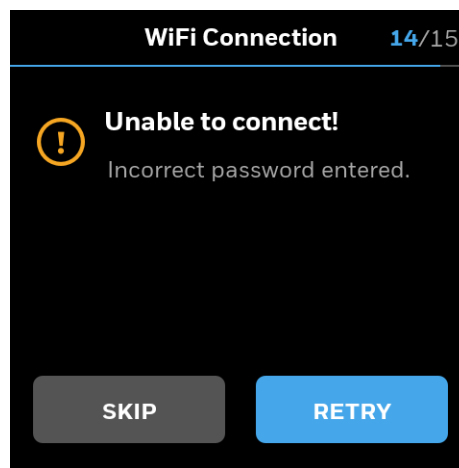
Figure 40 BACnet MS/TP manual MAC address



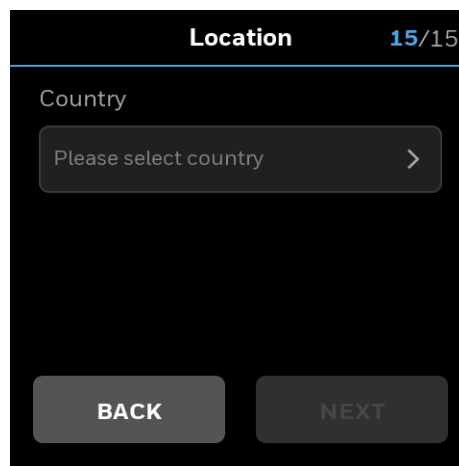
- 75. The device automatically adapts to the baud rate of the MS/TP network. You can also manually select the Baudrate.
- 76. To change the MS/TP setting, navigate back to BACnet MS/TP page and tap BACnet/MS/TP settings.  
 TC500A doesn't simultaneously support BACnet IP and BACnet MS/TP. When switching the connection between BACnet IP and BACnet MS/TP, TC500A will give a prompt, then restart automatically.  
 TC500A will try to adapt to the Baudrate of the MS/TP network in the first 4 minutes after startup or MS/TP is enabled. If no Baudrate could be determined, for example, there is a single device on the network, then TC500A will choose the default Baudrate of 76800. After that, the Installer can manually change it to another value.  
 After setting the BACnet MS/TP connection, the Location page appears.

**Note:** If the connection is unsuccessful, user can **RETRY** or **SKIP** setting Wi-Fi connection.

**Figure 41** Unsuccessful Wi-Fi connection



**Figure 42** Location



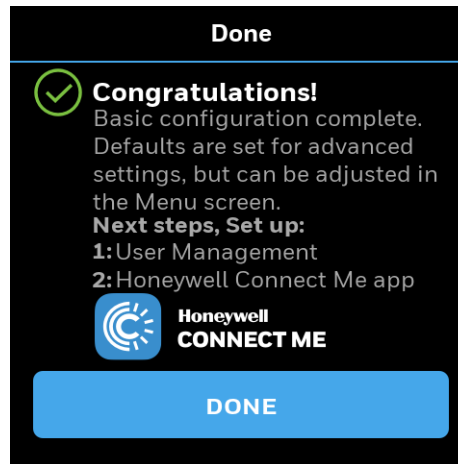
- 77. Select your country and enter Zip code.

**Note:** Based on the selected location, the outside temperature and humidity of the location from the Internet source will be displayed, if there are no sensors in the system.

78. Tap **NEXT**.

The Congratulations message appears.

**Figure 43** Successful connection



79. Tap **DONE**.

“Do you want to configure the user management now” message appears.

80. Tap **YES** to continue with user management or tap **NO** to start using the thermostat.

Thermostat Home page appears.

After set up the thermostat device, you can start configuring the user management schedules, alarms, and terminal assignments. To reconfigure initial setup, refer to [Device Configuration & Equipment Settings](#).

## Honeywell Connect Mobile App

The Honeywell Connect Mobile deploy app helps the installer to remotely manage the TC500A thermostat device. It includes initial configuration, general settings, equipment settings, setpoint management, sensors management, schedules, and mobile specific features. All operational procedures are similar to operating the thermostat device.

### Prerequisites

Go to the app store and search for “Honeywell Connect Mobile” to download the app. or, scan the QR code given below. Install the app on your mobile device, then create an account, and create a site.



**Honeywell Connect Mobile**  
Honeywell International, Inc.

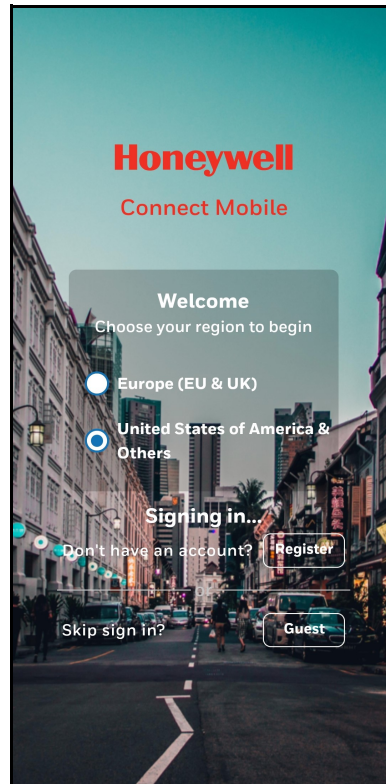


## Registering the mobile app

You must register yourself to the mobile app using your Organization's login credentials to use the mobile app.

1. Open the app, on the Log-in page, select your region, and tap **Register**.  
Contact your administrator if you are not sure about the region.

**Figure 44** Connect Mobile App - Log in Page

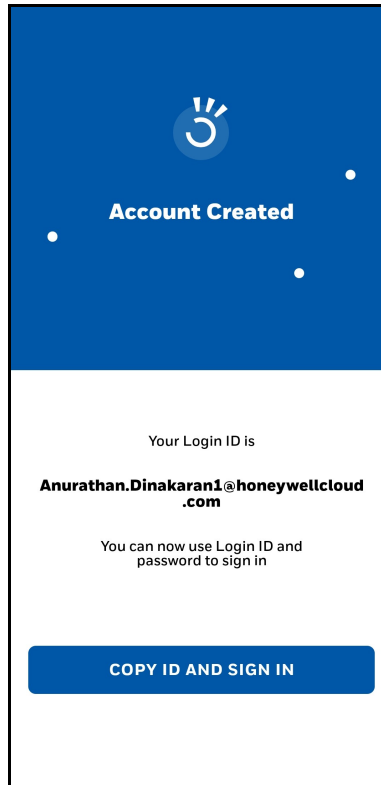


The TERMS OF USE page appears. Read the EULA and Privacy Policy, select both options and tap **AGREE**.

The Email verification page appears.

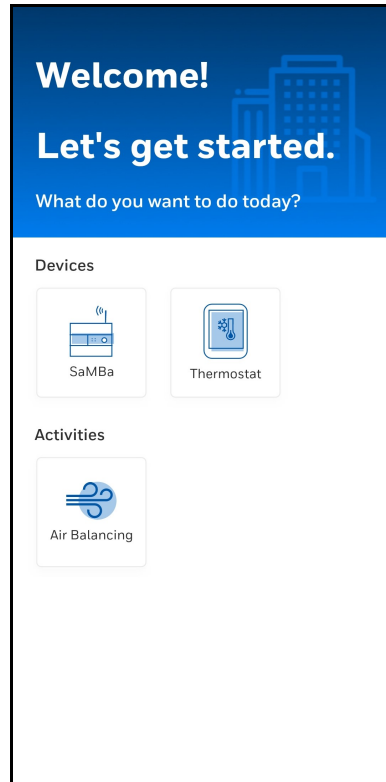
2. Enter your organization or personal Email ID and tap **SEND**.  
The Complete Registration page appears.
3. Enter your first name, last name, password for your account, and Organization name.
4. Tap **CREATE ACCOUNT**.

Figure 45 Account Created



The Account Created page appears. It displays your Login ID created to access the mobile app account. Please TAKE NOTE of this Login ID, as you will need it for future sign in.

5. Tap **COPY ID AND SIGN IN**.  
The HONEYWELL FORGE site opens on your default browser.
6. Paste the copied Login ID in the **Email or Username** box.
7. Tap **NEXT**.
8. Enter your password and take note of your password.
9. Tap **Sign in**.  
The More information required page appears.
10. Tap **Next**.
11. Tap your email ID to pick an account.
12. Set up your authentication email and security questions, and tap **finish**.  
The app permission page appears.
13. Read the content and tap **Accept**.  
The Home page of the application appears.

**Figure 46** Application - Home Page

## Adding the sites

14. On the Welcome page, tap **Thermostat** to set up a thermostat, or tap SaMBa if you are setting up a full SaMBa system.  
If you chose Thermostat, the Sites page appears.

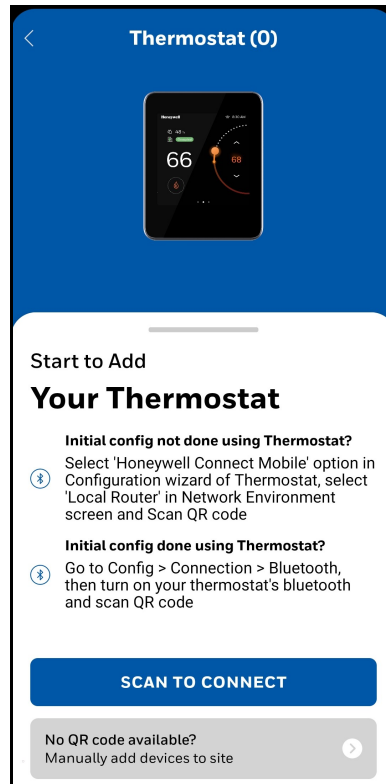
Figure 47 Adding a site

The screenshot shows a mobile application interface for adding a site. At the top, there is a back arrow and the title "Add Site". Below the title, there is a form with several input fields and dropdown menus. The "Organization name" field is pre-filled with "Honeywell". The "Site Name\*" field is empty. The "Country" dropdown menu is set to "United States". The "Time Zone" dropdown menu is set to "(UTC -05:00) America/Detroit". Below these are three more text input fields: "Address line 1\*", "Address line 2 (Optional)", and "City\*". At the bottom of the form is a blue button labeled "ADD SITE".

15. Tap **ADD SITE**.  
The Add Site page appears.
16. In **Site Name**, enter a name for the site. It is recommended the site name should be relevant to the actual site name for easy identification.
17. In **Country**, select the country of the site from the drop-down list.
18. Enter Address, City, State/Province, and Zip/Postcode in the corresponding boxes.
19. Tap **ADD SITE**.  
The Site is successfully created message appears and it will be added to Your Sites page.
20. Repeat the above procedure to add more sites.
21. Tap the added site.  
The Thermostat page appears.



Figure 48 Adding a thermostat



22. Read and perform the instructions given on-screen based on the initial configuration status of the thermostat.
23. Tap **SCAN TO CONNECT**.
24. Scan the QR code that appears on the thermostat device.  
The thermostat is added to the mobile application.


**Note:** *The Honeywell Connect Mobile app is a one-way communication from the app to the thermostat. Changes made on the thermostat UI will be overridden by the app when user taps “Apply” from the app. Make sure that the thermostat is online while applying changes via mobile app.*

25. To add thermostat manually, when the QR code is not available or working, tap **No QR code available?**  
The UUID page appears.
26. Enter the UUID of the thermostat.  
It asks you to enable Bluetooth and Wi-Fi on your mobile device and thermostat, if not enabled.  
The Create BLE Pin Code page appears.

Figure 49 BLE Pin Code

< Create BLE Pin Code

Please create a BLE Pin code for secure connection and make note for future use.

BLE Pin Code \* 

8-16 digits

No 3 characters repeating / sequence

CREATE

27. Enter a code for BLE and tap **CREATE**.  
The Validate BLE Pin Code page appears.
28. Re-enter the code and tap **VALIDATE**.  
The Wi-Fi Network page appears.

**Figure 50** Entering Wi-Fi Credentials

WiFi Network

**Choose your Wi-Fi network**

Which 2.4GHz Wi-Fi network you like to connect your thermostat?

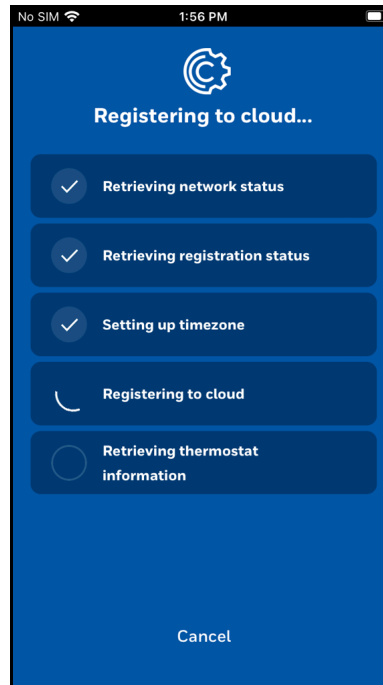
Select a SSID\*

Enter SSID password\*

Go to Settings > WiFi to select a SSID or add a new SSID manually and back to this app to continue thermostat configuration

**CONNECT**

29. Enter the Wi-Fi credentials.
30. Tap **CONNECT**.  
The Registering to cloud page appears.

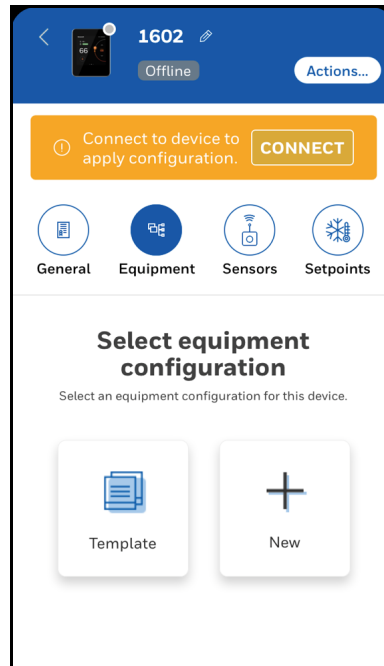
**Figure 51** Registering to cloud

Followed by the Your thermostat has been registered page appears.

31. Enter a name for the device.
32. Tap **ADD**.  
The Thermostat is added to the mobile application.

## Managing the thermostat parameters

33. Tap the added thermostat.  
The thermostat home page appears.  
The home page contains 4 major options such as General, Equipment, Sensors, and Setpoint as available on the thermostat device.
34. Tap the yellow-colored **CONNECT** button to sync the mobile app and thermostat device.

**Figure 52** Connecting the thermostat and mobile app

35. Tap **Template** to import the already defined configurations from default or custom templates. See [Saving/importing the configuration as a template](#).  
or
36. Tap **New** to manually set the equipment configurations.
37. Navigate through the options, configure the desired values and finally tap **Action > Apply**. This sends all changes to the thermostat and **Applied configuration successfully** message appears on the mobile app.

## Saving/importing the configuration as a template

38. On the home page, tap **Action > Save as Template** button.  
The Save as Template page appears. It displays the current configuration, you can edit the configuration if required.
39. Tap **Save**.  
The Template saved successfully message appears.  
All configuration set for the thermostat are saved as a template and added to the Template Management page. This template can be imported to the other thermostat for quick configuration.
40. To import a template, tap **Action > Import From Template**.  
Template Management page appears.
41. Select a template to import.  
Once applied, this will remove the previous equipment-related data from the thermostat and apply the new template data.

## Site Management

The added site information can be modified here. Such as editing site name, address, and time zone.

1. On the top left corner of the Sites page, tap the three-line icon, and tap **Site Management**.  
The Site Management page appears. It lists all sites created in your account.
2. Tap a site to reconfigure the details.
3. Tap **Site Users** to view the list of users associated with the site. If no users are available, then only admin is displayed.

## User Management

After creating a site, you can invite users to provide access to the site.

1. On the top left corner of the Sites page, tap the three-line icon, and tap **User Management**.  
The User Management page appears. It displays the Admin user.
2. Tap **ADD USER**.  
The Add User page appears.
3. Enter the Email address of the user.
4. Tap **Role\*** to provide a role of the user.
5. Enable access to the required sites by sliding the button to the right. A user can have access to multiple sites.
6. Tap **ADD USER**.  
An email will be sent to the registered user's mail ID. This email asks the user to download the Honeywell Connect Mobile app to their mobile device and register.  
The added user will be listed on the User Management page with registration pending status. After the registration is completed, the user can have access to the site (s).

## Template Management

Templates contain the predefined configuration of equipment, schedules, setpoints of a thermostat. If the configuration of a thermostat is saved as a template, the saved template will be listed here. You can re-import these templates to other thermostats.

1. On the top left corner of the Sites page, tap the three-line icon, and tap **Template Management**.  
If the mobile app is synced with a thermostat, then default templates and custom templates (if already created) appears.

## Configuring the Unit System and Time Format

The unit system and time format to be displayed on the mobile app can be configured. It will not affect the Unit system and Time format settings on the thermostat.

1. On the top left corner of the Sites page, tap the three-line icon, and tap **Settings**.  
The application settings page appears.
2. Tap **Unit system**.
3. Select a preferred unit system and time format.

4. Tap the close (X) button to save and exit the page.

## Sharing the logs of the application

Application log can be shared in the .txt format via all the share options available in the Android or iOS share environment.

1. On the top left corner of the Sites page, tap the three line icon, and tap **Settings**.  
The application settings page appears.
2. Tap **Share Logs**, number share options (Eg. Bluetooth, Wi-Fi) displayed in the mobile, select an option.
3. Shared logs are archived and available to view under **Archived Logs**.
4. Tap **Clear Logs** to clean up the archived logs.

## Integrating with Occupant app and Cloud registration

The user can remotely monitor and configure the site parameters using the Occupant app. This mobile app integration also helps to register the thermostat with the Cloud network and subsequently supports Over-the-air (OTA) firmware upgrade.

### Prerequisites

- Go to the app store and search for “Honeywell Connect Me” to download the app. or, scan the QR code given below. Install the app on your mobile device, then create an account, and create a site.



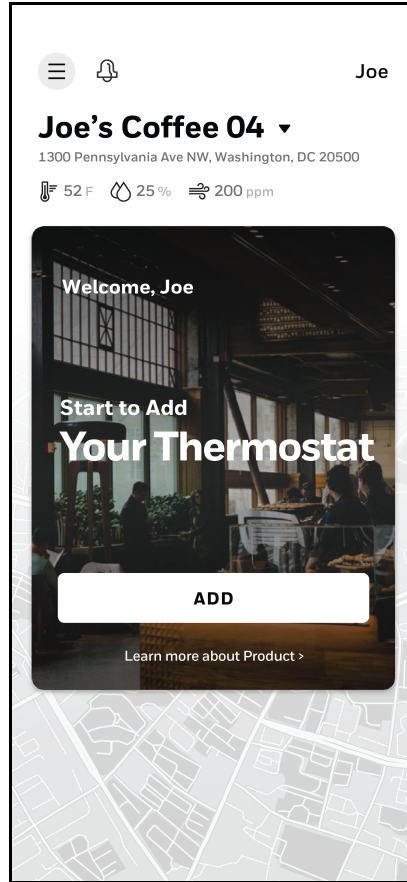
### To integrate with the Occupant app and Cloud registration

1. Turn on Bluetooth on the thermostat. Refer to [Bluetooth](#).
2. On the Occupant app, after app registration and site creation, you will be prompted to add a thermostat.

The following page appears.

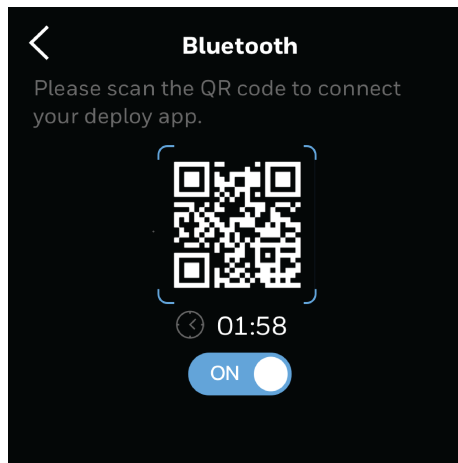


Figure 53 Occupant app - Adding thermostat



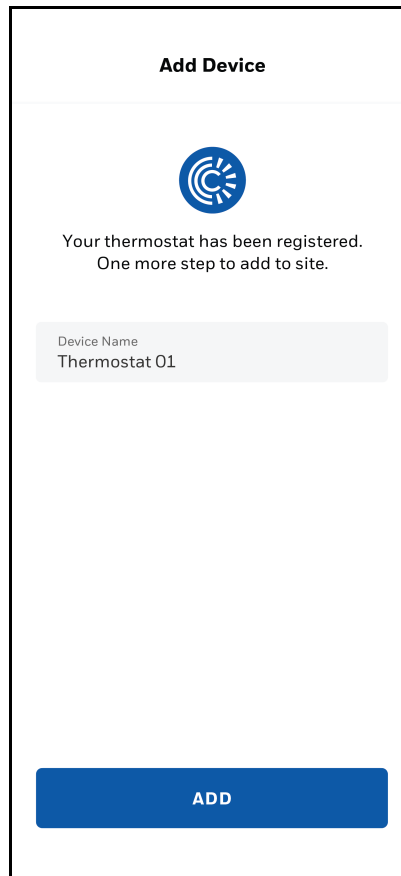
3. Tap **Add**.
4. Tap **SCAN TO CONNECT**.
5. Scan the QR code that appears on the thermostat Bluetooth page.

Figure 54 Thermostat - Bluetooth page



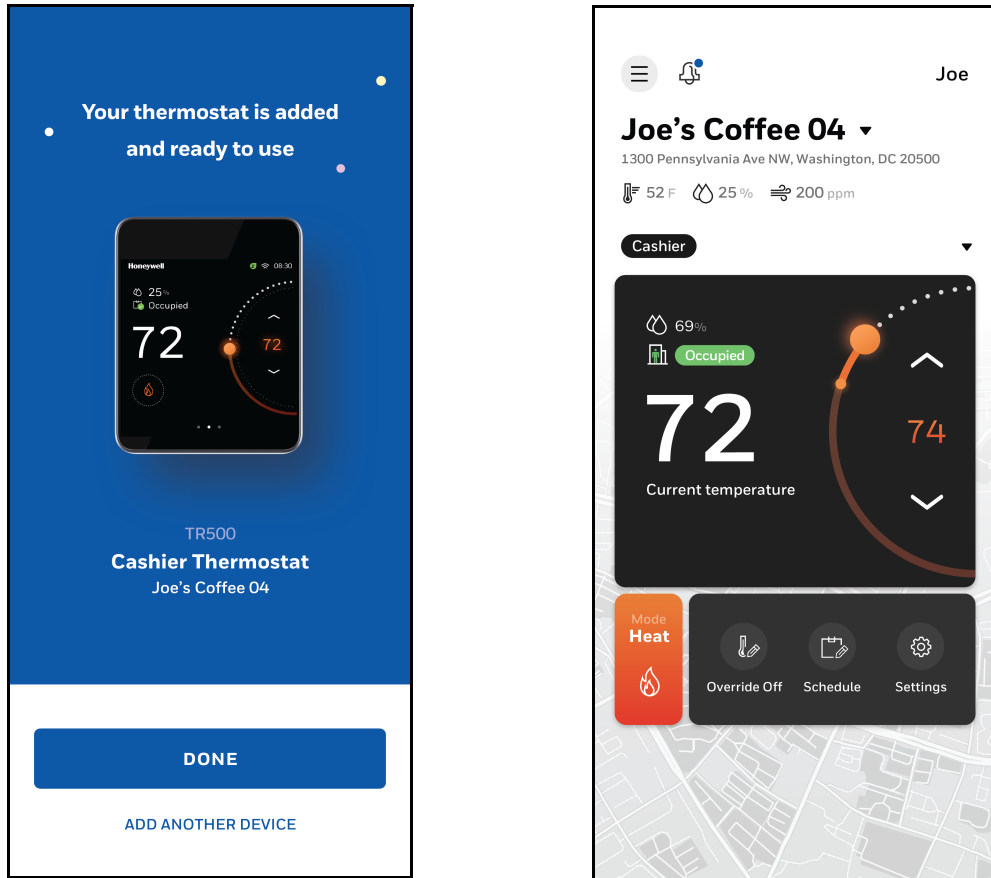
- The **Successfully Connected** message appears on the Occupant app if connected successfully.  
Subsequently, the thermostat will be registered to the cloud and registration message appears. Then, the Add Device page appears.

**Figure 55** Add Device - Naming thermostat



- You can rename the device name, then tap **ADD**. This will update the thermostat name in the actual thermostat itself.  
If the thermostat name is renamed then the Updated thermostat name appears.  
After a successful connection, the “Your thermostat is added and ready to use” message appears.

Figure 56 Thermostat is added to the Occupant app



8. Tap **DONE**.  
Registered thermostat home page appears on your mobile.  
To remove the registration, refer to [Configuring the Home page \(Display Management\)](#).



# Device Configuration & Equipment Settings

This chapter contains thermostat level configuration and equipment level configuration procedures. Only the Installer has access to these configuration pages.

## Related topics

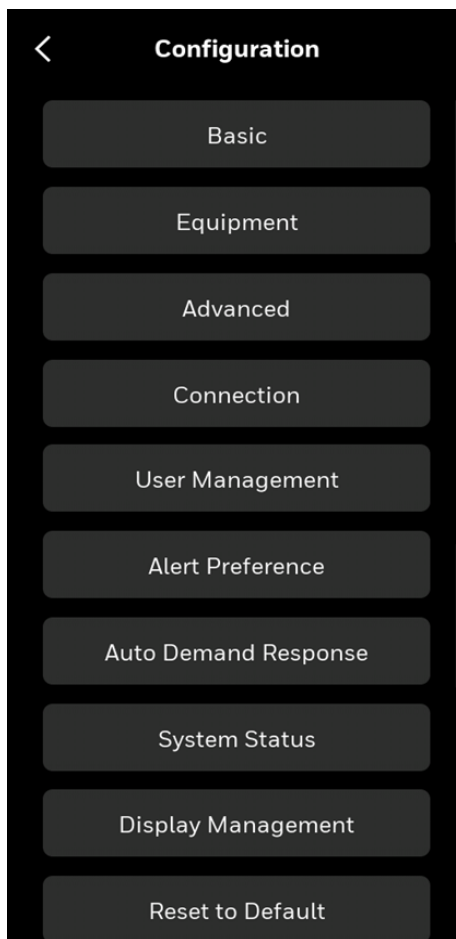
- [Configuration page](#)
- [Basic configuration](#)
- [Configuring equipment](#)
- [Managing the internal economizer](#)
- [Enabling the external economizer](#)
- [Advanced configuration](#)
- [Configuring the thermostat I/O terminals](#)
- [Configuring the sensors](#)
- [Configuring the Syk devices](#)
- [Configuring Delta T Diagnostics](#)
- [Managing setpoint options](#)
- [Configuring Purge](#)
- [Miscellaneous](#)
- [Enabling the Service mode](#)
- [Viewing the Security log](#)
- [Managing the thermostat connection](#)
- [Configuring the user roles](#)
- [Configuring the alarm preference](#)
- [Configuring Auto Demand Response](#)
- [Viewing the system status](#)
- [Configuring the Home page \(Display Management\)](#)
- [Reset to Default](#)

## Configuration page

The configuration page displays all the configuration items of the thermostat and equipment.

1. Swipe left from the Home page.
2. On the Quick access page, tap **Config**.  
The Configuration page appears.

**Figure 57** Configuration page

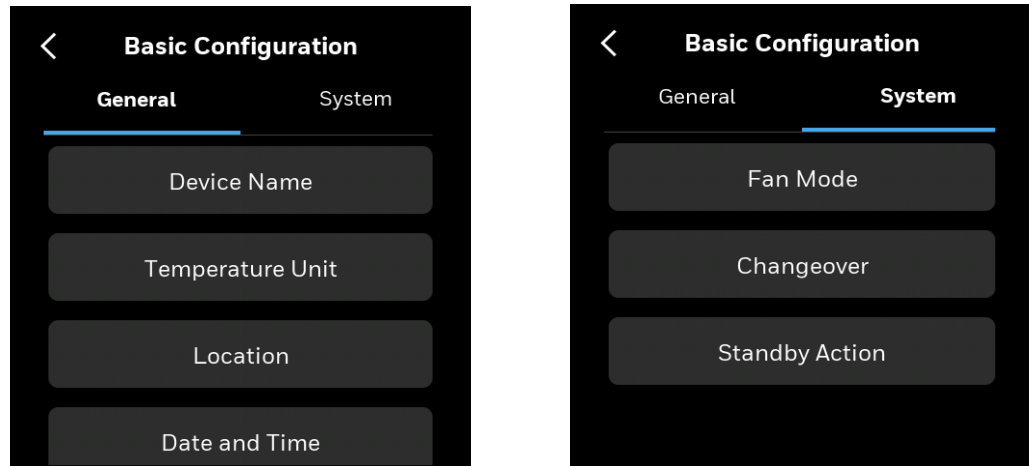


## Basic configuration

The Basic tab contains two tabs such as General and System.

General tab includes Device name, Temperature unit, Date & Time, Screen cleaning, Brightness, and Contractor information. System tab includes Fan Mode, Changeover, and Standby Action. You might have configured some of these settings while initial set up. However, you can reconfigure these settings again.

**Figure 58** Basic configuration



The following features are covered under the Basic configuration.

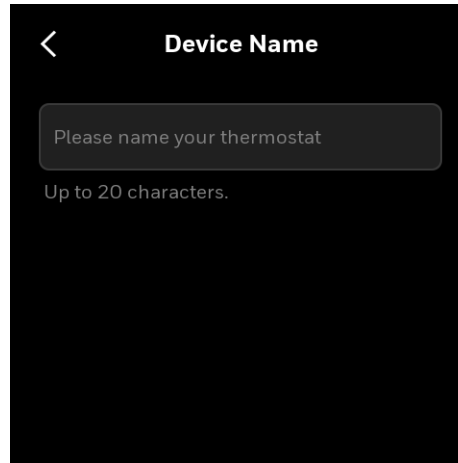
- To rename the device name
- To change the temperature unit
- To set the Location of the device
- To configure Date & Time
- To configure Daylight savings
- To enable screen cleaning mode
- To adjust the display brightness
- To modify contractor information
- To configure Fan Mode
- To configure Changeover
- To set up Standby Action
- Pre-occupancy purge

## General

### To rename the device name

1. Swipe left from the Home page.
2. On the Quick access page, tap **Config > Basic > Device Name**.  
The Device name page appears.

**Figure 59** Naming the thermostat



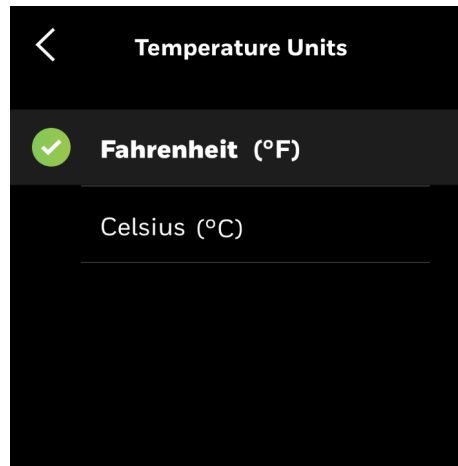
3. Tap on the text field  
A keyboard will be displayed on the screen to enter the device name.
4. Enter the device name.  
Assign a unique name to a thermostat specifying a name to the location where the thermostat is installed. It assists the user to easily identify the device during remote operation of the thermostat.
5. Tap the back button to navigate back to the previous page and save the settings.



### To change the temperature unit

1. Swipe left from the Home page.
2. On the Quick access page, tap **Config > Basic > Temperature Unit**.  
The Temperature Unit page appears.

Figure 60 Temperature unit

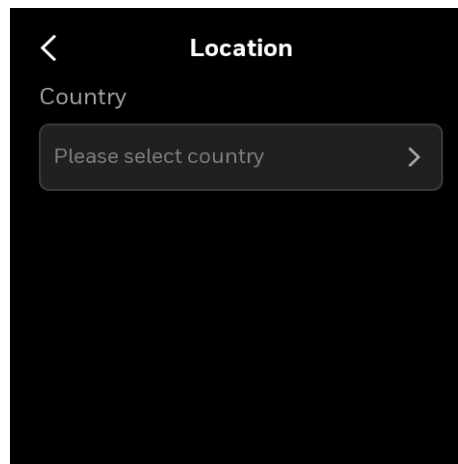


3. Select a temperature unit.
4. Tap the back button to navigate back to the previous page and save the settings.

### To set the Location of the device

1. Swipe left from the Home page.
2. On the Quick access page, tap **Config > Basic > Location**.  
The Location page appears.

Figure 61 Location



3. Tap Please select country and select a country from the drop-down list.
4. Enter the Zip code of the selected country.
5. Tap the back arrow button to save the settings.

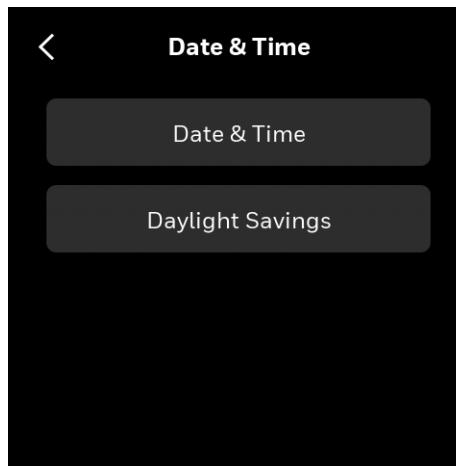
### To configure Date & Time

The date and time of the thermostat is synced with local time automatically after a successful connection. However, if the thermostat date and time is not synced automatically, then you can manually set it.

You can configure the Date & time and Daylight savings.

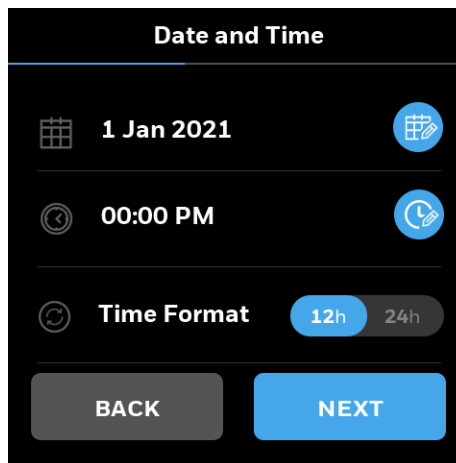
1. Swipe left from the Home page.
2. On the Quick access page, tap **Config > Basic > Date & Time**.  
The Date & Time page appears.

Figure 62 Date & Time



3. Tap Date & Time.  
The Date and Time page appears.

Figure 63 Date and Time Config page



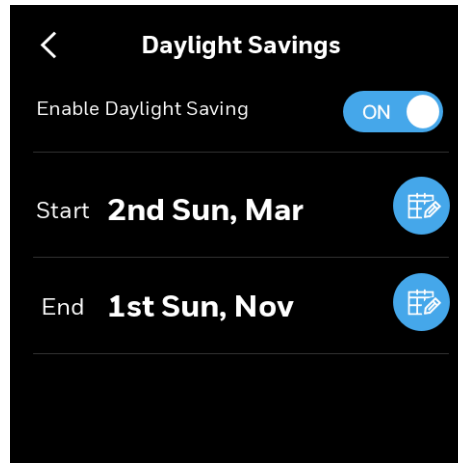
4. Tap the calendar pen icon to set the date.
5. Tap the clock icon to set the time.
6. Slide the toggle button to the right to set the 24h time format if required.
7. Tap the back button to navigate back to the previous page.

### To configure Daylight savings

**Note:** This feature is not available if the thermostat is configured via Honeywell Connect Mobile or Honeywell Connect Me apps.

1. Swipe left from the Home page.
2. On the Quick access page, tap **Config** > **Basic** > **Date & Time** > **Daylight Savings**.  
The Daylight Savings page appears.

Figure 64 Daylight savings page



The Daylight Saving is on by default.

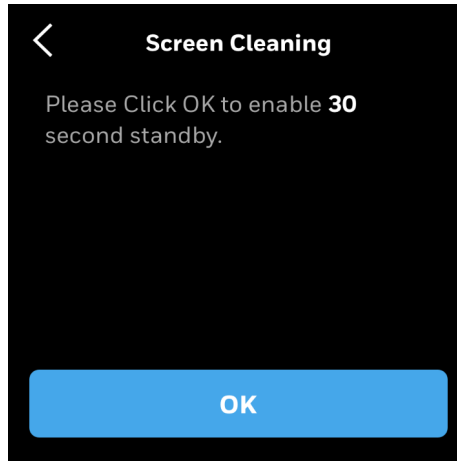
3. Tap the Start calendar pen icon to set the start date for daylight savings.
4. Tap the End calendar pen icon to set the end date for daylight savings.
5. To disable the daylight light savings, slide the Enable Daylight Saving toggle button to left.
6. Tap the back button to navigate back to the previous page.

### To enable screen cleaning mode

Screen cleaning mode lock/disable the touch sensitivity of the display for 30 seconds so you clean the device display while the thermostat is functional.

1. Swipe left from the Home page.
2. On the Quick access page, tap **Config** > **Basic** > scroll down > **Screen Cleaning**.  
The Screen Cleaning page appears.

Figure 65 Screen cleaning

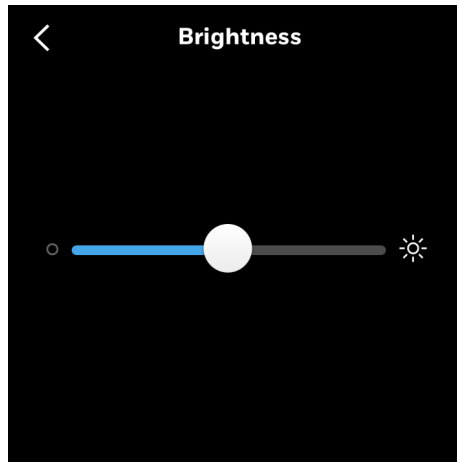


3. Tap OK to enable the screen cleaning mode for 30 seconds or tap the back button to navigate back to the previous page.

#### To adjust the display brightness

1. Swipe left from the Home page.
2. On the Quick access page, tap **Config > Basic > scroll down > Brightness**. The Brightness page appears.

Figure 66 Brightness



3. Move the slider to right or left to adjust the brightness.
4. Tap the back button to navigate back to the previous page.

#### To modify contractor information

You might have added the Contractor information while performing initial setup. To modify that information, follow the procedure given below.

1. Swipe left from the Home page.
2. On the Quick access page, tap **Config > Basic > scroll down > Contractor Information**. The Contractor Information page appears.

Figure 67 Contractor information

Contractor Information

Name

Phone

Email

3. Modify Name, Phone, and Email address of the contractor.
4. Tap the back button to navigate back to the previous screen and save the modified information.

## System

### To configure Fan Mode

1. Swipe left from the Home page.
2. On the Quick access page, tap **Config > Basic > System > Fan Mode**. The Fan Mode page appears.

Figure 68 Fan mode

Basic Configuration

General System

Fan Mode

Changeover

Standby Action

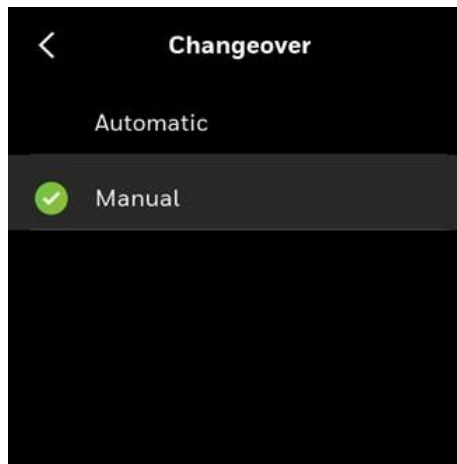
Table 18: Basic configuration

Operation	Configuration Type	Configuration Select	Range	Description
Fan	Mode	Continuous	Default is Continuous	The fan will run continuously during occupied periods for ventilation, and during unoccupied periods will run the fan only when there is a call for cool or heat (if fan on in heat is configured).
		Auto		In occupied and unoccupied periods, the fan runs with a call for cooling or heat (when fan on in heat is configured)
		Circulate		The fan runs approximately 35% of the time, roughly 20 minutes each hour, minus any time the fan is already running with the heating or cooling system

**To configure Changeover**

1. Swipe left from the Home page.
2. On the Quick access page, tap **Config > Basic > System > Changeover**.  
The Changeover page appears.

Figure 69 Changeover



3. Tap a required option.
4. Tap the back button to navigate back to the Equipment page.

**To set up Standby Action**

The Standby Action refers to which mode setpoints to be used while the thermostat is in Standby mode. You can select either Occupied mode or Unoccupied mode.

1. Swipe left from the Home page.
2. On the Quick access page, tap **Config > Basic > System > Standby Action**.  
The Standby Action page appears.

3. Tap Treat as Occupied or Treat as Unoccupied.

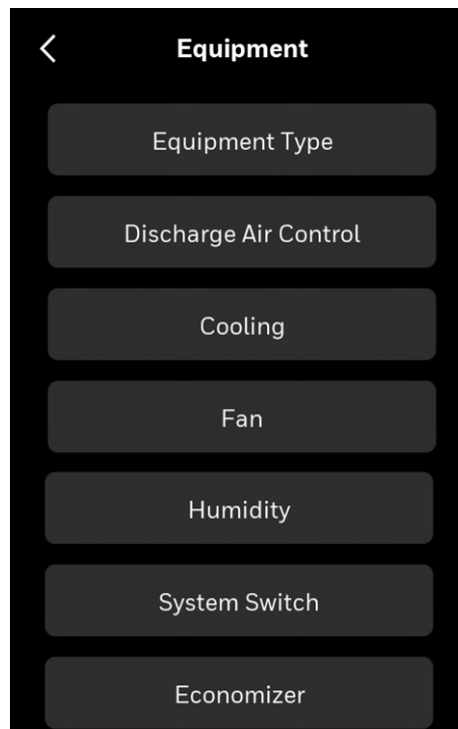
## Configuring equipment

This section contains procedures to reconfigure the equipment type, cooling heating, fan, humidity, system switch, and economizer management.

### To configure Equipment

1. Swipe left from the Home page.
2. On the Quick access page, tap **Config > Equipment**.  
The Equipment page appears.

Figure 70 Equipment

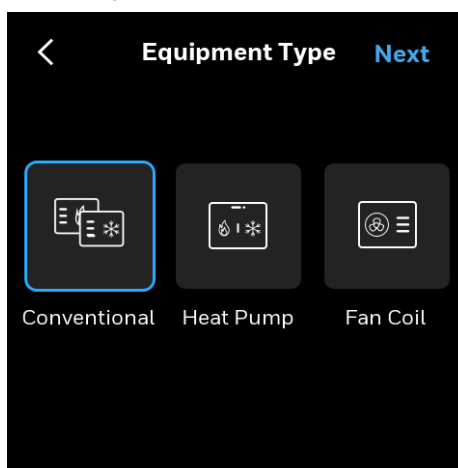


**Note:** The discharge air control option is available only if the selected equipment type is Fan coil with floating or modulating valves.

### To configure Equipment type

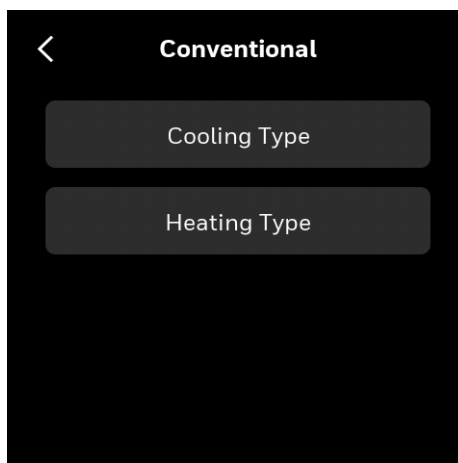
1. Swipe left from the Home page.
2. On the Quick access page, tap **Config > Equipment > Equipment type**.  
The Equipment Type page appears.

Figure 71 Equipment type



- To configure conventional equipment, tap **Conventional** and tap **NEXT**. The Conventional page appears.

Figure 72 Conventional settings

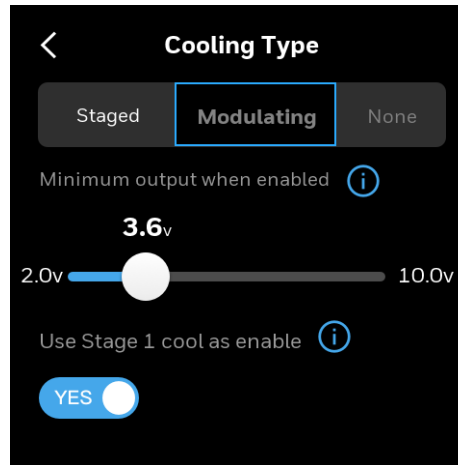


- Tap **Cooling Type**. The Cooling Type page appears.
- Under the Staged tab, select a required number of cooling stages (max 4).
- To use the modulating cool type, tap **Modulating**.

**Note:** *Modulating cool can be utilized only if the relevant equipment is configured in the UIO1 or UIO2 terminal.*



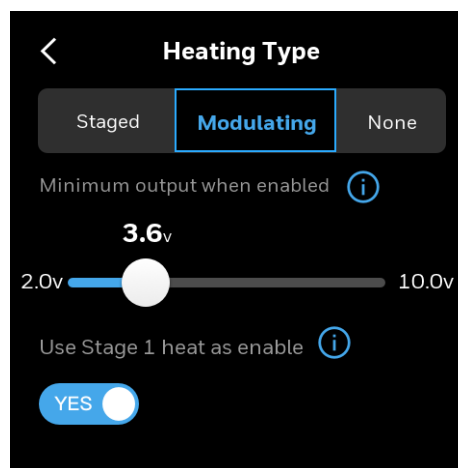
Figure 73 Modulating cool



7. Toggle the **Use stage 1 cool as an enable** button to **YES**, if system requires an enable signal.
8. Swipe the slider to select the desired minimum voltage output when cooling is active.
9. If no cooling is required, tap **None**.
10. After selected an option, tap the back button to navigate back to the Conventional page.
11. Tap **Heating Type**.  
The Heating Type page appears.
12. Under the Staged tab, select a required number of heating stage.
13. To use the modulating heat type, tap **Modulating**.

**Note:** *Modulating heat can be utilized only if the relevant equipment is configured in the UIO2 terminal.*

Figure 74 Modulating heating



14. Toggle the **Use stage 1 heat as an enable** button to **YES**, if system requires an enable signal.
15. Swipe the slider to select the desired minimum voltage output when cooling is active.
16. If no heating is required, tap **None**.

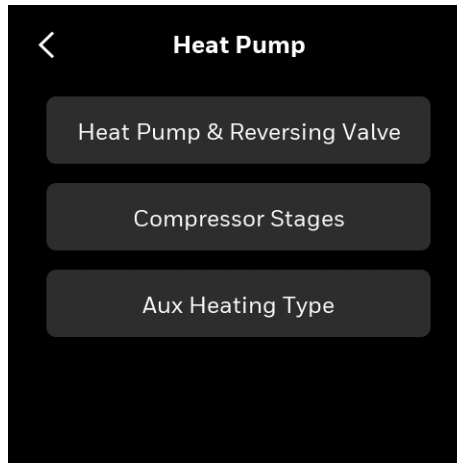
17. After selected an option, tap the back button to navigate back to the Conventional page.

18. Tap the back button to navigate back to the Equipment Type page.

### To configure the Heat Pump

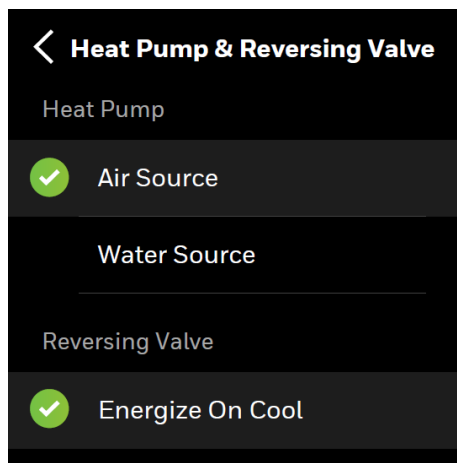
1. On the Equipment Type page, tap **Heat pump**, and tap **NEXT**.  
The Heat Pump page appears.

Figure 75 Heat pump



2. Tap **Heat Pump & Reversing Valve**.  
The Heat Pump & Reversing Valve page appears.

Figure 76 Heat pump & reversing valve

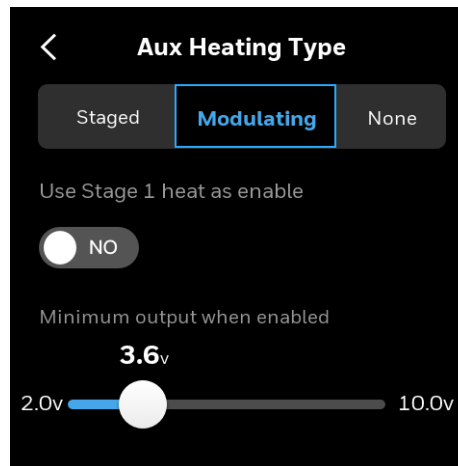


3. Select a source for heat pump and reversing valve.
4. Navigate back to the previous page.
5. Tap **Compressor Stages**.  
Select a required compressor stage number.
6. Tap the back button to navigate back to the Heat Pump page.
7. Tap **Aux Heating Type**.
8. Under the Staged tab, select a required number of heating stage.

9. To use the modulating heat type, tap **Modulating**.

**Note:** *Modulating aux heat can be utilized only if the relevant equipment is configured in the UIO2 terminal.*

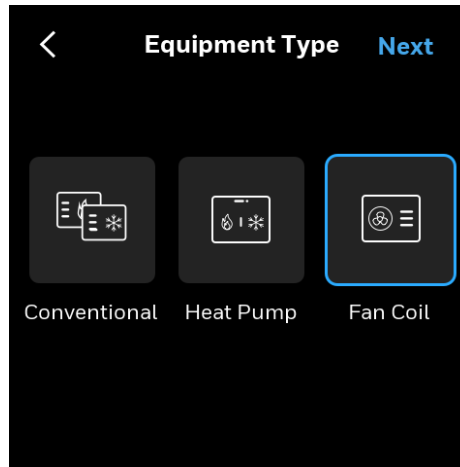
Figure 77 Modulating heating



10. Toggle the **Use stage 1 heat as an enable** button to **YES**, if system requires an enable signal.
11. Swipe the slider to select the desired minimum voltage output when heating is active.
12. If no heating is required, tap None.  
Tap the back button to navigate back to the Heat Pump page.

To configure the Fan coil

Figure 78 Fan coil



TC500A-N offers limited support for fan coil systems: 4-Pipe Dual systems as well as 2-pipe Single Dedicated Heat only or Cool only systems (without changeover). Please see table below for details on support available.

Table 19: Fan coil application table

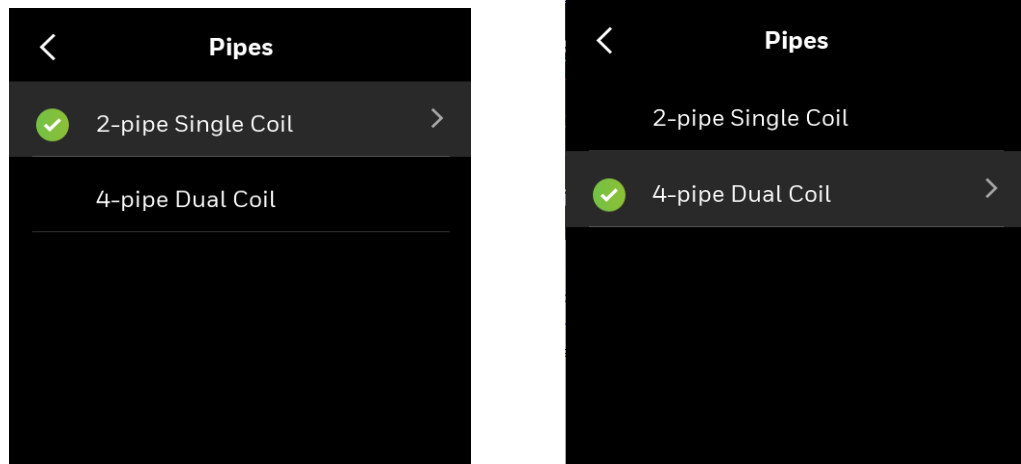
FCU Type	Coil Type	Primary CW/HW	Fan	Comments	Discharge Air Sensor Fan Status	Drain pan Sensor	Pipe Sensor Change-over	Aux Heat
4-Pipe	Dual	2-Pos	Single Speed	Not Currently Available	Optional - Monitor	Yes	Not Applicable	Not Applicable
			Two-Three Speed					
			Variable Speed					
		Modulating	Single Speed		Optional - Monitor			
			Two-Three Speed		Optional - Control/Monitor			
			Variable Speed		Optional - Control/Monitor			
		Floating	Single Speed		Optional - Monitor			
			Two-Three Speed		Optional - Control/Monitor			
			Variable Speed		Optional - Control/Monitor			

Table 19: Fan coil application table

FCU Type	Coil Type	Primary CW/HW	Fan	Comments	Discharge Air Sensor Fan Status	Drain pan Sensor	Pipe Sensor Change-over	Aux Heat
2 Pipe	Single	2-Pos	Single Speed	Dedicated Heat or Cool only; Heat/Cool Changeover not available.	Optional - Monitor	Yes	Not Currently Available	Use Conventional equipment configuration (single speed fan only)
			Two-Three Speed					
			Variable Speed					
		Modulating	Single Speed		Optional - Monitor			
			Two-Three Speed		Optional - Control/Monitor			
			Variable Speed		Optional - Control/Monitor			
		Floating	Single Speed		Optional - Monitor			
			Two-Three Speed		Optional - Control/Monitor			
			Variable Speed		Optional - Control/Monitor			
							Not Currently Available	

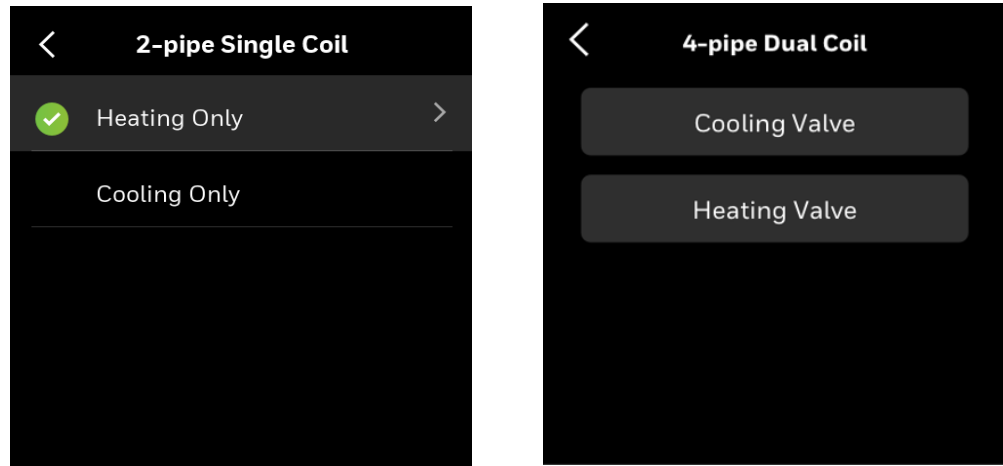
1. On the Equipment Type page, tap **Fan Coil**.  
The Pipes page appears.

Figure 79 Fan coil - Pipes



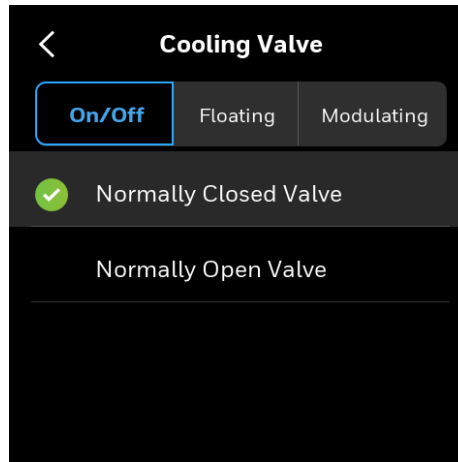
2. Tap **2-pipe Single Coil** or **4-pipe Dual Coil** based on the actual fan coil installed on the field.  
The 2-pipe Single coil or 4-pipe Dual coil page appears.

Figure 80 2-pipe single coil or 4-pip dual coil



3. Tap **Heating Only** for coil heating or tap **Cooling Only** for coil cooling. Based on the selection, Heating Valve and/or Cooling Valve page appears. Both pages have same options.

Figure 81 Cooling valve

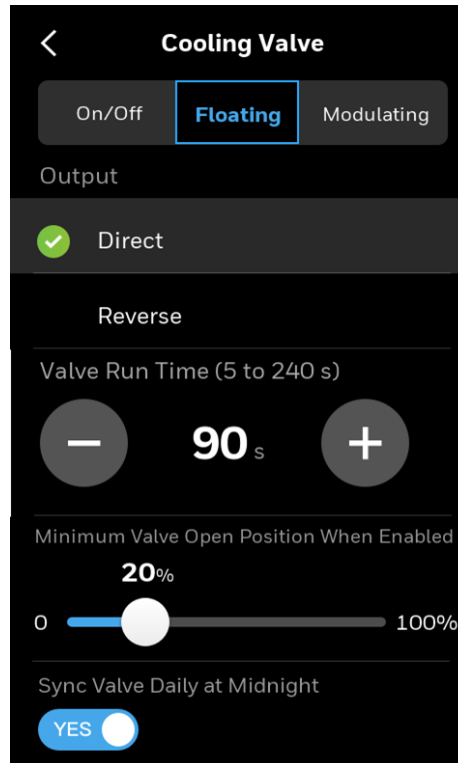


User can select On/Off, Floating, or Modulating valve type. Whatever cooling valve type is selected, the same will be applied to the heating valve type and vice-versa.

If the valve type is **On/Off**, select **Normally Closed Valve** or **Normally Open Valve**.

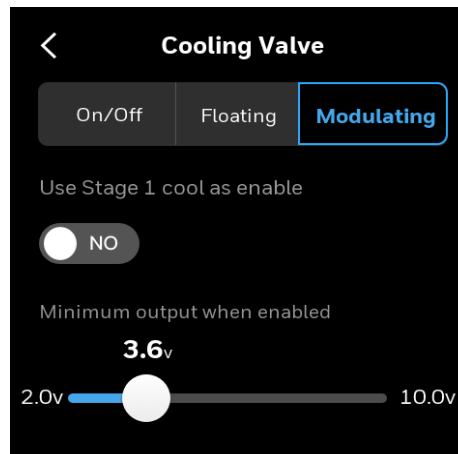
If the valve type is **Floating**, then floating related options appear.

Figure 82 Cooling valve - Floating position



If the type is **Modulating**, set the required values.

Figure 83 Cooling valve - Modulating position



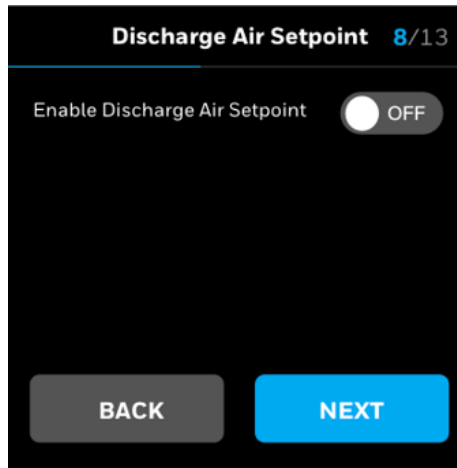
**Use Stage 1 cool as Enable / Use Stage 1 heat as Enable:** When set to YES, will also energize the W1 or Y1 terminal when there is an active call for heating or cooling. This can be used to send a demand call to a zone system, energize a circulation pump or energize a perimeter heat valve.

**Minimum Output When Enabled:** Setting is used to adjust the minimum voltage to the valve when there is an active call for heating or cooling. This setting can be used to set the minimum position on a control valve or minimum load on a variable speed compressor. Minimum Output when Enabled will function as Maximum output when enabled if Control Action is set to Reverse Acting. Control Action, Min. Output, Max.

Output settings can be adjusted in the Configurable I/O menu under the assigned UIO terminal.

If the valve position is selected as Floating or Modulating, then the Discharge Air Setpoint page appears. This is not applicable for the On/Off valve position.

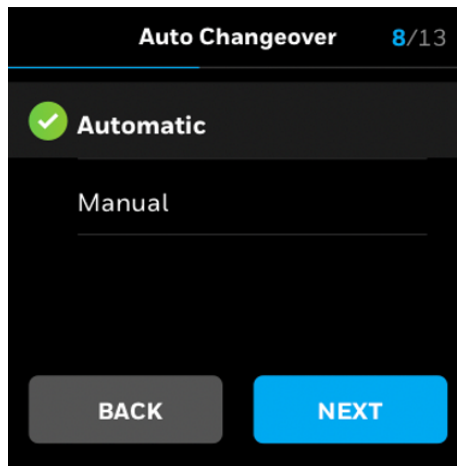
**Figure 84** Discharge air setpoint



If the selected coil type is 4-pipe dual coil, then the Auto Changeover page appears or the Fan Type page appears.

#### To configure Auto changeover

**Figure 85** Auto changeover for 4-pipe dual coil



1. Tap **Automatic** or **Manual**.

#### To configure Fan type

1. Swipe left from the Home page.
2. Tap **Config > Equipment > Fan > Fan Options > Speed Type**.  
The Speed Type page appears.



Figure 86 Fan - Speed type

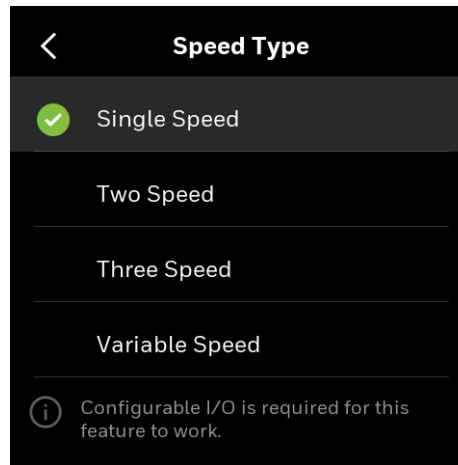


Table 20: Fan coil - Fan speed type

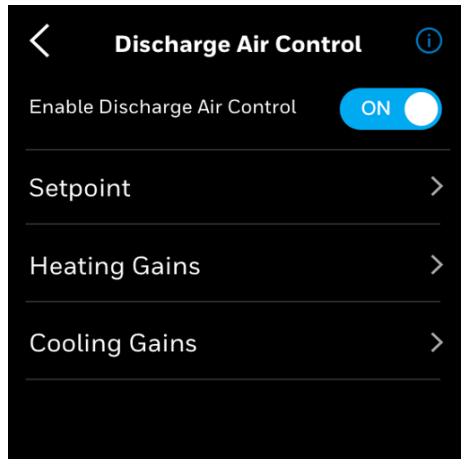
Speed type	Configuration select	Range
Single speed	-	-
Two speed	Multiple Output at a Time	-
	One Output at a Time	-
	Vent mode	High, Low
Three speed	Multiple Output at a Time	-
	One Output at a Time	-
	Vent mode	High, Medium, Low
Variable speed	Cooling mode	Min speed 0 to 100% (Default 20%) Max speed 0 to 100% (Default 100%)
	Heating mode	Min speed 0 to 100% (Default 10%) Max speed 0 to 100% (Default 50%)
	Ventilation mode	Fan speed 0 to 100% (Default 20%)

#### To configure discharge air control

The discharge air controller option is available only if the selected equipment type is Fan coil with the floating or modulating valve.

1. Swipe left from the Home page.
2. Tap **Config > Equipment > Discharge Air Control**.  
The Discharge Air Control page appears.

Figure 87 Discharge air control

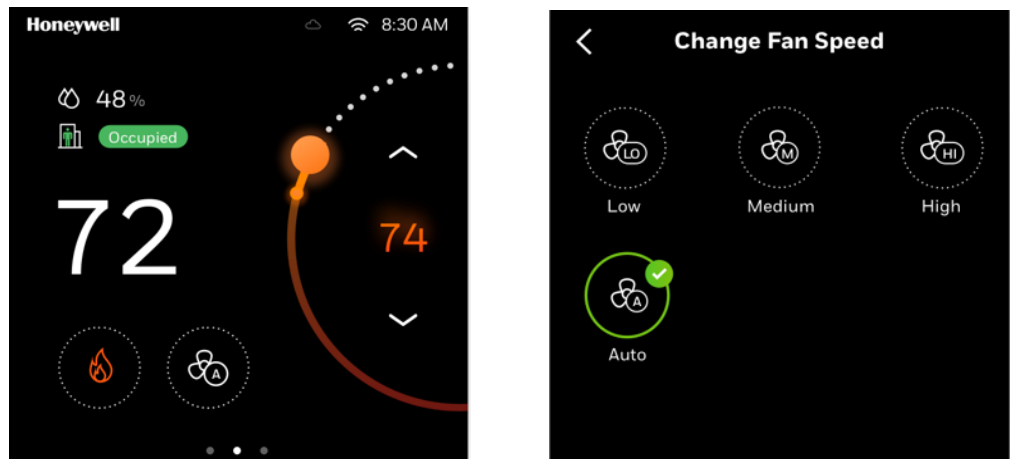


3. Enable the Discharge Air Control.
4. Tap **Setpoint**.
5. Enable the Discharge air control.  
The setpoint of discharge air control appears.
6. Set the desired limits.
7. Navigate back to the Discharge Air Control page.
8. Tap **Heating Gains**.
9. Set the Throttling range, Heating integral gain, and Heating derivative gain limits.
10. Tap **Cooling Gains** and set the limits.

**To change the fan speed**

1. On the home page, tap the fan icon.  
The Change Fan Speed appears.

Figure 88 Change fan speed



**To configure the operational limits of equipment**

1. Swipe left from the Home page.

2. Tap **Config** > scroll down > **Advanced** > **Equipment**.

The Equipment page appears. It contains the following equipment control options.

**Tip:** Long press the **+/-** button to quickly increase or decrease the value.

**Table 21: Equipment Configuration**

Operation	Configuration Type	Configuration Select	Range	Description
Heat Pump	Mode	Savings	(Default)	The controller will minimize the use of auxiliary heat to save energy. See Aux Heat Droop for more information.
		Comfort	N/A	The controller uses auxiliary heat as needed in addition to the compressor to keep the space comfortable.
	Lockouts	Compressor Lockouts	0-70°F(Default 30)	During heating mode, when the outside air temperature is below the Heat Pump Compressor Lockout setpoint, the compressor stages are disabled and the auxiliary heating is allowed to run.
		Auxiliary Heat Lockouts	30-120°F (Default 65)	During heating mode, when the outside air temperature is above the Heat Pump Aux Heat Lockout setpoint, the auxiliary stages will be disabled. However, if the compressors are locked out by outside air temperature or the unit is commanded to emergency heat mode, the auxiliary heat stages are allowed to run.

Table 21: Equipment Configuration

Operation	Configuration Type	Configuration Select	Range	Description
Heat Pump	Auxiliary Heat	Aux Heat Ramp Factor	0-100 (Default 2)	Ramp is used when the thermostat is recovering from the unoccupied heat stages from being used during this period, the user can specify an auxiliary heat ramp factor. This creates a second recovery ramp setpoint for the auxiliary heat. If the heat compressors cannot maintain its recovery ramp or are locked out when the outside air temperature is low, the auxiliary heat ramp will be used to allow auxiliary heat to recover before the occupied period.
		Aux Heat Droop	0-10°F (Default 0)	When the "Savings" mode is selected for heat pump control, then this configuration is shown. Droop is the number of degrees the ambient temperature is allowed to drop while the compressor is running before the auxiliary heat is engaged (provided auxiliary heat is not locked out). This lowers the auxiliary heat setpoint below the compressor setpoint to minimize use of auxiliary heat to save energy.
		Upstage Timer	30-960mins (Default OFF)	This timer starts when the highest stage of the previous heating equipment type turns on. Aux Heat will be used (if needed) when the timer expires.

Table 21: Equipment Configuration

Operation	Configuration Type	Configuration Select	Range	Description
Cooling	Minimum Times	Cooling Min. Off Time	0-300s (Default 60s)	The thermostat has a built in compressor protection (minimum off timer) that prevents the compressor from restarting too early after a shutdown. This timer is activated after the compressor is shut by the thermostat.
		Cooling Min. On Time	0-300s (Default 120s)	The minimum time the cooling system will be active. Set as recommended by the manufacturer. When a heat pump is configured, the TC500 will follow the cooling (compressor) min on and off times, whereas the AUX heat stages will follow the heating min on and off times.
	Lockouts	OAT (Outside Air Temperature) Cooling Lockout Setpoint	-40°F-120°F (Default 35°F)	When the outside air temperature is below the cooling lockout setpoint, the cooling control will be disabled. When the outside air temperature is above the cooling lockout setpoint plus 2 °F differential, the cooling control is enabled.
		DAT (Discharge Air Temp) Cooling Low Limit	-40-60°F (Default 45°F)	When the discharge air temperature is below the discharge air low limit setpoint, the cooling control will turn off stages of cool until the discharge air temperature rises above it's setpoint plus a 2 °F differential

Table 21: Equipment Configuration

Operation	Configuration Type	Configuration Select	Range	Description
Cooling	Gains	Throttling Range	0-30°F(Default 0°F -Auto)	<p>When the TC500 is configured for modulating cool it will output an analog Vdc signal (default:2-10 VDC) on the UIO1 or UIO2 terminals. UIO terminal and signal range settings are found in the Configurable I/O menu. Proportional error is the deviation from set point of the sensed temperature divided by the throttling range. The set point is the temperature at which the control loop is satisfied. When the sensed temperature is at set point there is no proportional error and the output is 0%.</p> <p>The throttling range is the amount of change in the sensed temperature required to drive the output from 0 to 100%. The throttling range must be narrow enough to provide good control without becoming unstable. The throttling range is determined by factors including: the control application, heating or cooling capacity of the equipment relative to the physical size of the space being controlled, and the control algorithm being used. The narrower (smaller) the throttling range, the more precise the control and the wider (larger) the throttling range, the more stable the control. The objective is setting the throttling range to achieve the optimum balance between precision and stability.</p> <p>When the TC500 is configured for staged cool it will use the TR to tune the PID loop for staged cool control. The throttling range controls the cycling of the system and helps to compensate for load changes, equipment sizing and thermostat mounting location.</p> <p>When set to 0 (Auto), the TC500 sets the throttling range based on the number of stages selected. The TC500 also sets integral time based on the TR.</p> <p>1 stage: TR 3 °F                  2 stages: TR 4 °F                  3 stages: TR 6 °F                  4 stages: TR 7 °F</p>

Table 21: Equipment Configuration

Operation	Configuration Type	Configuration Select	Range	Description
Cooling	Cycles Per Hour	Cooling Cycles Per Hour	2-20 CPH (Default 3)	The maximum number of cycles per hour the thermostat cycles the equipment at 50% load. Honeywell recommends 3 CPH for conventional cooling or heat pump.
Heating	Minimum Times	Heating Min. Off Time	0-300s (Default 60s)	The minimum time the between calls for heat.
		Heating Min On, Time	0-300s (Default 120s)	The minimum time duration of a call for heat.
	Lockouts	OAT Heating Lockout Setpoint	40-120°F (Default 65°F)	OAT Heating lockout set points defined as when outside air is above the lockout, it will not allow heating to be enabled. When the outside air temperature is below the heating lockout setpoint less a 2 °F differential, the heating control is enabled.
		DAT Heating High Limit	65-140°F (Default 140°F)	When the discharge air temperature is above the discharge air high limit setpoint, the heating control will turn off stages of heat until the discharge air temperature falls below its setpoint minus a 2 °F differential. This will help prevent the discharge air temperature from getting too hot and avoid tripping limits.

Table 21: Equipment Configuration

Operation	Configuration Type	Configuration Select	Range	Description
Heating	Gains	Throttling Range	Auto(0) Default to 30°F	<p>When the TC500 is configured for modulating heat it will output an analog Vdc signal (default:2-10 VDC) on the UIO1 or UIO2 terminals. UIO terminal and signal range settings are found in the Configurable I/O menu.</p> <p>Proportional error is the deviation from set point of the sensed temperature divided by the throttling range.</p> <p>The set point is the temperature at which the control loop is satisfied. When the sensed temperature is at set point there is no proportional error and the output is 0%.</p> <p>The throttling range is the amount of change in the sensed temperature required to drive the output from 0 to 100%. The throttling range must be narrow enough to provide good control without becoming unstable.</p> <p>The throttling range is determined by factors including, the control application, the response time of the equipment being controlled, and the control algorithm being used. The narrower (smaller) the throttling range, the more precise the control and the wider (larger) the throttling range, the more stable the control. The objective is setting the throttling range to achieve the optimum balance between precision and stability.</p> <p>When the TC500 is configured for staged heat it will use the TR to tune the PID loop for staged heat control. The throttling range controls the cycling of the system and helps to compensate for load changes, equipment sizing and thermostat mounting location.</p> <p>When set to 0 (Auto), the TC500 sets the throttling range based on the number of stages selected. The TC500 also sets integral time based on the TR.</p> <p>1 stage: TR 3 °F                  2 stages: TR 4 °F                  3 stages: TR 6 °F</p>



Table 21: Equipment Configuration

Operation	Configuration Type	Configuration Select	Range	Description
Heating	Cycles Per Hour	Heating Cycles Per Hour	2-20 CPH (Default 6)	The maximum number of cycles per hour the thermostat cycles the equipment at 50% load. The default cycle rate for heat (conventional) or Aux heat (Heat pump) is 6 and for cool (conventional) or compressor (Heat pump) is 3. Honeywell recommends these settings: -Gas Heat: 6 CPH -Heat Pump: 3 CPH -Electric: 9 CPH
Fan	Run with heat	On/Off	Default On	When set to On, thermostat will run the fan with a call for heat (and cool). Select off when controlling a heating system that operates the system fan in heat. When fan on heat is configured to Off and thermostat is configured for heat pump operation, a call for compressor heat will always turn on fan output (G).
		Fan extended runtime in heating	0-300s (Default 90s)	Fan run on time after all heating stages are turned off. May be used to run fan after all heating stages have turned off so that the heat exchanger can cool down before the fan turns off.
		Fan extended runtime in cooling	0-300s (Default 0s)	Fan run on time after all cooling stages are turned off. May be used to run fan after all cooling stages have turned off so that the cooling (DX) coil can warm up before the fan turns off to prevent condensation from evaporating into the space.
Fan	Speed Type	Single Speed	N/A	Terminal G (DO1) is energized on a call for fan.

Table 21: Equipment Configuration

Operation	Configuration Type	Configuration Select	Range	Description
		Two Speed	Vent Mode Cool Single Stage Cool Multi Stage, Heat Single Stage Heat Multi Stage All Other Modes	<p>One of these terminals can be configured for low speed fan: W3 (DO4), Y3 (DO7), or DO8. G (DO1) for High Speed Fan When in low speed fan, only the configured terminal is active, and when in high speed fan, only the G (DO1) is active. When configured for heat pump application and both compressor heat and auxiliary heat stages are on, the unit uses the maximum of the speeds selected for the compressor and auxiliary heat.</p> <p>See the note in the Multiple Speed section for more information on fan speed assignments.</p>
Fan	Speed Type	Multiple Speed	Speeds Configuration (Assign speeds to 6°Fan speed configurations) Speed Assignment (Assign speeds 1-6 to ventilation and stage modes)	<p>G (DO1) is fan start/stop UI01°For 0-10 VDC as analog output to vary the speed of the fan.</p> <p>When modulating heating control/ Auxiliary modulating heating is used, the fan speed will start with the configured minimum speed and will ramp towards configured maximum. The fan will require a minimum 5% output from modulating control or the modulating output should be greater than Cfg_Heat_ModHtEnSp, which ever setpoint is greater in order to start ramping up.</p> <p><b>Note:</b> Use Speed Configuration to set speeds for up to 6°Fan speeds. Then use Speed Assignment to assign those speeds to each equipment mode. When the thermostat calls for first stage equipment, it will run the fan at the Cool Single Stage speed, or Heat Single Stage speed. When it calls for second stage or higher, it will run the fan at the Multi-Stage speed. The Vent Mode speed will be used when the thermostat is not calling for heating or cooling equipment but is calling for fan, such as when it is in the Occupied mode.</p>

Table 21: Equipment Configuration

Operation	Configuration Type	Configuration Select	Range	Description
Fan	Speed Type	Variable Speed	Cooling Mode Heating Mode Ventilation Mode	<p>Variable Speed Fan is used together with Conventional 1H/1C system. In this use case, the heating/cooling stage controls, the heating/cooling valve, and the fan speed vary according to the actual heating/cooling demand. Users can configure max/min speed for heating and cooling separately. The UIO1 terminal is dedicated to the Variable Speed Fan if it is selected, Users can choose between 0/10V and 2/10V according to the input characteristic of the Fan.</p> <p><b>Note:</b> <i>The Variable Speed Fan options are available only when the below conditions are all met.</i></p> <ol style="list-style-type: none"> <li>1. Equipment Type is Conventional.</li> <li>2. Both heating and cooling type should be Staged or None, but not Modulating.</li> <li>3. Both heating and cooling stages should not be more than 1.</li> <li>4. Economizer type should be None.</li> </ol>

Table 21: Equipment Configuration

Operation	Configuration Type	Configuration Select	Range	Description
Humidity	Dehumidification	Simple - Space relative humidity high limit, Dehumidification off delay	0-100% Rh (Default 65% Rh)	The TC500 dehumidifies to a configured humidity high limit with on/off control using external dehumidification equipment. When relative humidity (Rh) rises above the setpoint, the TC500 will energize the W3 (DO4), Y3 (DO7), or DO8 terminal (as configured by user in Configurable I/O menu.) When the space Rh falls 5% points below this setpoint, it will de-energize this terminal. Once active, the dehumidification cycle will be on for a minimum amount of time configured with the Dehum On Delay, 20 minutes default, configurable from 0-60 minutes. The supply fan will operate based on configured fan type under following mode: -If Fan is configured as Single Speed, then supply fan will run in default mode -If Fan type is configured as Two Speed, then supply fan will run in lowest fan speed -If Fan type is configured as Variable Speed, then supply fan will run as per configured under Speed Type/Assignments The TR40-H Sylk bus sensor may be used for space humidity (and temperature) sensing.
		Staged Reheat - Space relative humidity high limit, Dehumidification off delay, Enable Minimum on time operation	0-100% Rh (Default 65% Rh) Staged Reheat (Default Off) Minimum On Time (Default Off) Minimum On Time 240-1200s (Default 600s) Minimum On Delay 0-60 min (Default 20 min)	When the TC500 is configured for at least one stage of cooling and heating, staged reheat can be used. When in cooling mode, and the space Rh rises above the setpoint, the first stage of cooling & heating will turn on. When the space cooling control is calling for more than 1 stage of cooling, staged reheat operation will be disabled.  The heating section must be located downstream of the cooling coil to provide reheat.

Table 21: Equipment Configuration

Operation	Configuration Type	Configuration Select	Range	Description
Humidity	Humidification	Space relative humidity high limit	0-100% Rh (Default 35% Rh)	<p>The TC500 humidifies to a configured humidity low limit with on/off control using external humidification equipment. When the space relative humidity (Rh) is less than the Rh low limit setpoint the TC500 will engage the W3 (DO4), Y3 (DO7), or DO8 terminal (as configured by user in Configurable I/O menu.) When the space humidity rises above the low limit setpoint plus 5% RH differential this terminal will be disengaged. As soon as the humidify function goes inactive the supply fan will go OFF after with a delay of 2 minutes.</p> <p>The supply fan will operate based on configured fan type under following mode:</p> <ul style="list-style-type: none"> <li>-If Fan s configured as Single Speed, then supply fan will run in default mode</li> <li>-If Fan type is configured as Two Speed, then supply fan will run in lowest fan speed</li> <li>-If Fan type is configured as Variable Speed, then supply fan will run as per configured under Speed Type/Assignments The TR40-H Sylk bus sensor may be used for space humidity (and temperature) sensing.</li> </ul>
		Humidification on delay	0-60 min (Default 20 min)	Once active, the humidity action will be ON for minimum of this amount of time.
System Switch	System Switch	Choice of system switch to correspond to HVAC equipment	Heat, Cool, Auto, EMER Heat, Off	<p>Select a system switch that corresponds with the HVAC equipment.</p> <p>Networked commands to control the system switch mode take precedence over the setting on the TC500.</p> <p>The system switch setting is saved during power outages.</p>
			Heat, Cool, Auto, Off	
			Heat, Cool, Off	
			Heat, Off	
			Cool, Off	
Economizer	Economizer	None		
		Internal Economizer controller		Refer to <a href="#">Managing the internal economizer</a>

Table 21: Equipment Configuration

Operation	Configuration Type	Configuration Select	Range	Description
		External Economizer		Enabling the external economizer

## Managing the internal economizer

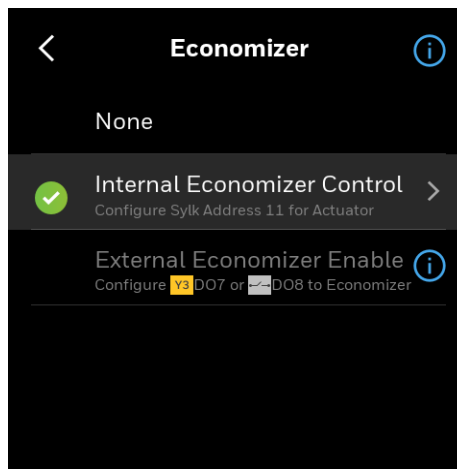
This section describes the procedure to enable and manage the internal economizer. The procedure includes configuring the Sylk devices, Free cooling configuration, Ventilation configuration, Coil freeze protection configuration, and damper position configuration. Before using this feature, make sure that Sylk 11 address is configured for the actuator. Refer to [Activating the Sylk actuator](#) and [Configuring the sensors](#).

**Note:** An information icon with description of feature is provided on most of the pages. Tap the icon to understand the feature.

### To configure the internal economizer

1. Swipe left from the Home page.
2. Tap **Config > Equipment > Economizer**.  
The Economizer page appears.

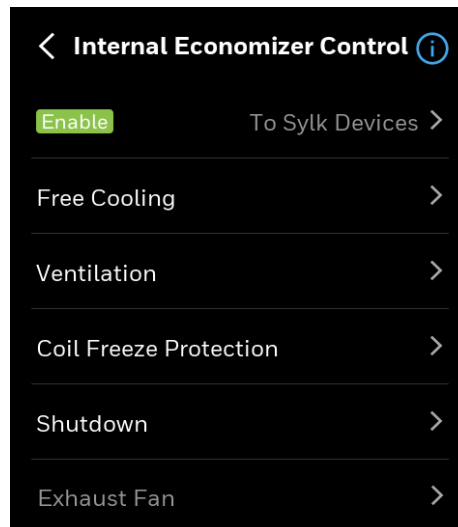
Figure 89 Internal economizer



3. Tap **Internal Economizer Control**.

If the following message appears “Sylk device has exceeded maximum limit. Please disable Sylk device(s) until under the maximum threshold, and then select Internal Economizer Control. Would you like to go to the SylkDevice settings menu?” tap **YES**, it takes you to Sylk Devices page. Disable a few of the configured the devices. Navigate back to the Economizer page. General guideline: TC500A will support (1) Sylk Actuator, (2) TR40’s and (1) TR40-CO2.

If Sylk devices are configured for the required actuator then the Internal Economizer Control page appears.

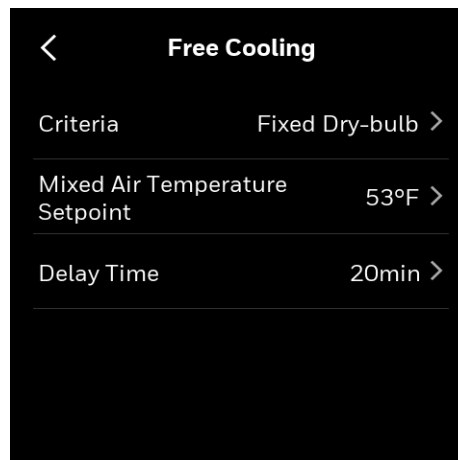
**Figure 90** Internal economizer control

4. Tap **To Sylk Devices** to jump to Sylk Devices page for further configuration. Refer to [Activating the Sylk actuator](#)

## Free cooling

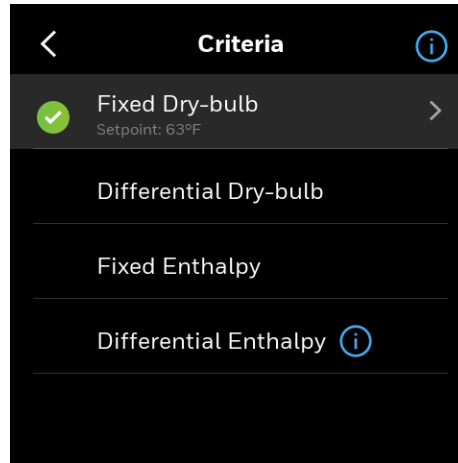
The free cooling feature can be configured by setting the temperature difference between OAT and dry-bulb Setpoint. Or, configuring the Enthalpy.

5. Tap **Free Cooling**.  
The Free Cooling page appears.

**Figure 91** Free cooling

6. Tap **Criteria**.  
The criteria page appears. It lists four criteria to enable the free cooling.

Figure 92 Criteria for free cooling



7. Tap the options to set up the desired criteria. Refer to [Criteria](#).
8. Navigate back to the Free Cooling page.
9. Set **Mixed Air Temperature** setpoint.
10. Set **Delay Time** for mechanical cooling.
11. Navigate back to **Internal Economizer Control** page.

## Ventilation

The ventilation system can be configured for Demand Control Ventilation (DCV) to regulate the amount of air used for ventilation depending on the level of occupancy in the space. The level of occupancy is measured using a connected carbon dioxide (CO<sub>2</sub>) sensor.

Vent. Min. Position is set to maintain the ventilation rate needed by the building at low/no occupancy level. Vent. Max. Position is set to maintain the ventilation rate need by the building at full occupancy. For single speed fan these settings are represented by High speed settings in the chart below.

For two speed fan Vent. Min and Max. positions are set for both Low and High speed fan to maintain the ventilation rate independent of fan speed.

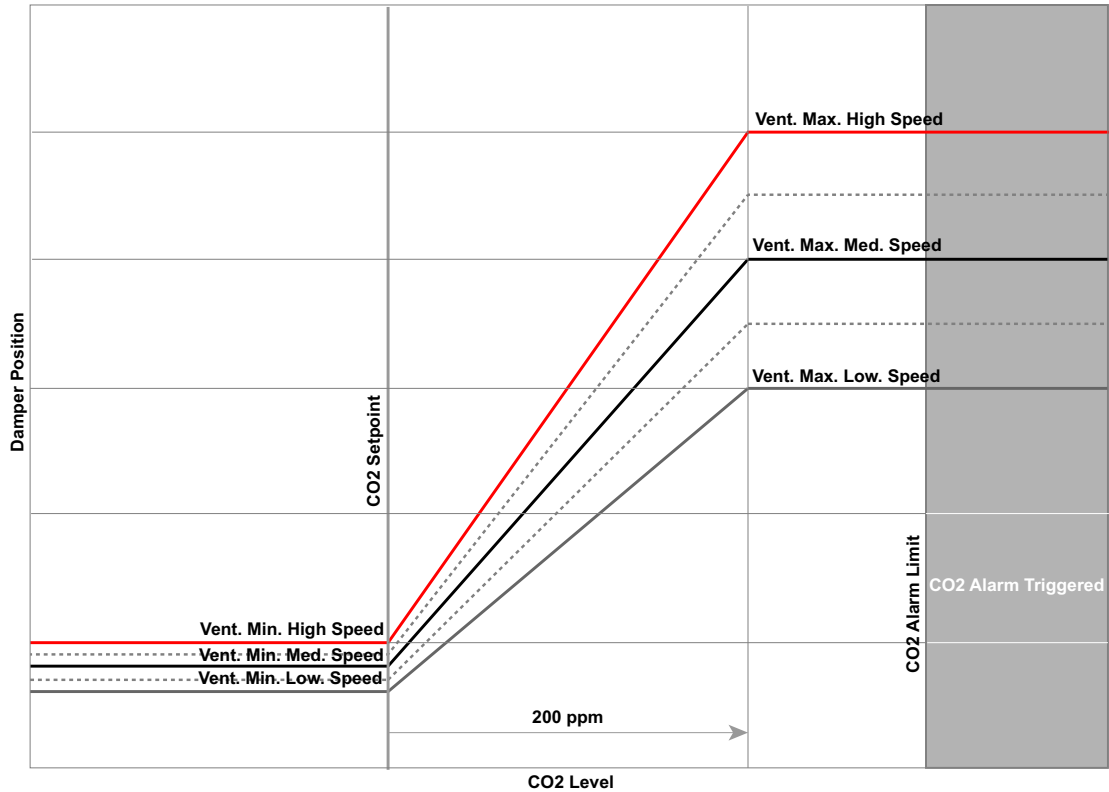
For variable speed fan, Vent. Min and Max. positions are set for Low and High speed settings correspond to the lowest and highest configured speeds. Med. speed settings correspond to a reference point halfway between the highest and lowest configured speeds. Vent. Min. and Max. positions will be interpolated for fan speeds between the highest and lowest speed using the programmed Low, Med. and High speed positions.

During the occupied period the ventilation position will be increase from Vent. Min. to Vent. Max. of the current fan speed over a 200 ppm throttling range, reaching Vent. Max. Position 200 ppm above CO<sub>2</sub> Setpoint. Ventilation position will return to Vent. Min. when CO<sub>2</sub> levels drop 100 ppm below the set point.

An alarm will be triggered if the CO<sub>2</sub> level exceeds the CO<sub>2</sub> Alarm Limit. It is recommended to set CO<sub>2</sub> Alarm Limit at least 300 ppm above CO<sub>2</sub> setpoint to avoid nuisance alarming.



Figure 93 DCV damper position



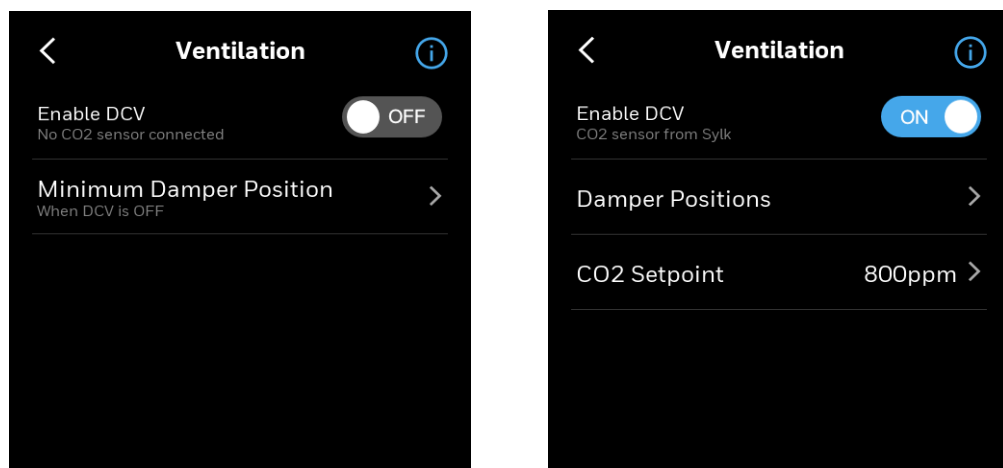
During Economizing the damper will be modulated between the current ventilation position and 100% full open to maintain the Mixed Air Setpoint.

If no CO2 sensor is connected, the ventilation system can be configured to maintain a fixed minimum outdoor air rate during the occupied period. Minimum ventilation positions are set for each fan speed to maintain ventilation rate across all fan speeds.

12. Tap **Ventilation**.

The Ventilation page appears.

Figure 94 Ventilation



13. Enable DCV by sliding the **OFF** button to **ON**.

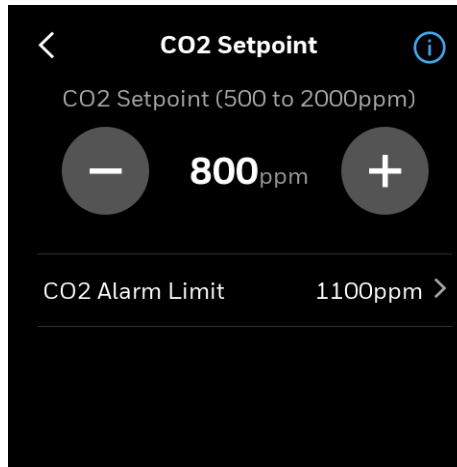
Once DCV is enabled, the **CO2 Setpoint** option is available to configure.

14. Tap the right arrow of the **Damper Positions**.  
The Damper Positions page appears. If DCV is not enable **Minimum Damper Position** menu is available. Options vary based on the single, two and variable speed fan configurations.
15. Set minimum and maximum ventilation positions for dampers.
16. Navigate back to the Ventilation page.

**Note:** Step 17 to 20 is not available if DCV is set to OFF.

17. Tap the right arrow of **CO2 Setpoint**.  
The CO2 setpoint alarm page appears.

Figure 95 CO2 setpoint

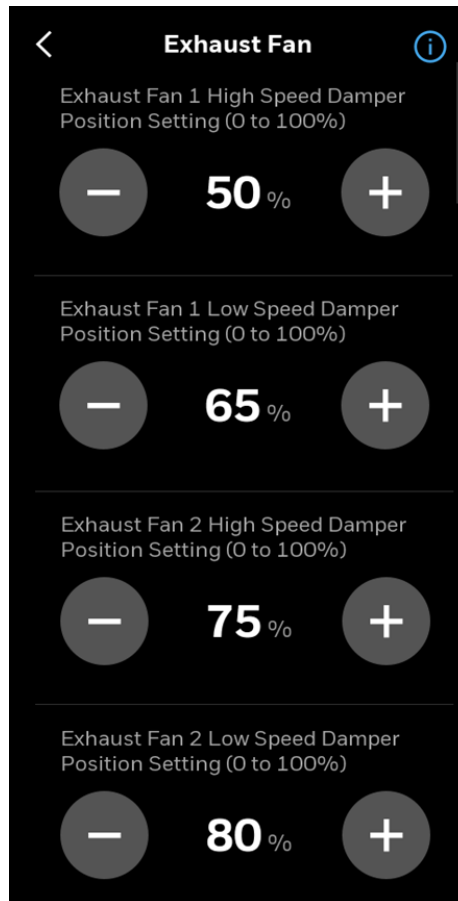


18. Set the CO2 level in ppm.
19. Tap right arrow of the **CO2 Alarm Limit**.  
The CO2 Alarm Limit page appears.
20. Set the CO2 alert limit.  
You can view the CO2 alarms by navigating via **Config > Alert Preference > Alarm Limits > CO2 limit**. Refer to [Unacknowledged alarms](#).
21. Navigate back to the Internal Economizer Control page.

## Exhaust fan

A maximum of two exhaust fans can be configured for the internal economizer. The damper positions to trigger the exhaust fans can be configured. To configure exhaust fan on I/O terminals. See [Configuring the thermostat I/O terminals](#).

22. Tap **Exhaust Fan**.  
The Exhaust Fan page appears. This page is dynamic. Based on the single speed fan, two fan speed, or multiple speed fan type, the number of damper position settings vary.

**Figure 96** Typical exhaust fan 2 speed settings

23. Configure the damper settings.

24. Navigate back to Internal Economizer Control page.

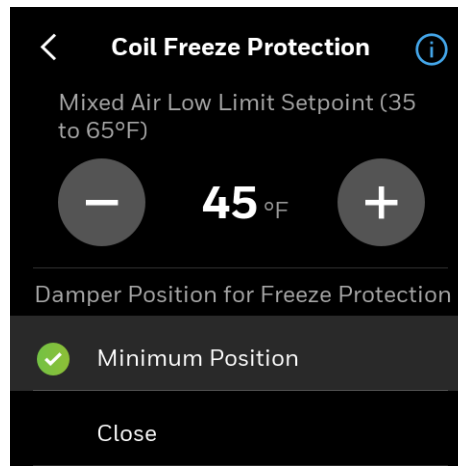
## Coil freeze protection

Coil freeze protection provides protection for mechanical equipment in colder climates. For systems with hot or chilled water coils, freeze protection helps protect against damage to coils due to freezing. You can configure it by setting up mixed air low limit setpoint and damper position for freeze protection.

25. Tap **Coil Freeze Protection**.

The Coil freeze protection page appears.

Figure 97 Coil freeze protection



26. Set the mixed air low limit setpoint and damper position for freeze protection.
27. Navigate back to **Internal Economizer Control** page.

## Shutdown

The Shutdown option allows a common signal (configured on UI, UIO or over BACnet) to be sent to one or more RTUs as a Shutdown signal. When Shutdown is active the OA damper will go to the programmed position, Open or Close. All other control, e.g., Y1, Y2, W1, W2, G will shut off.

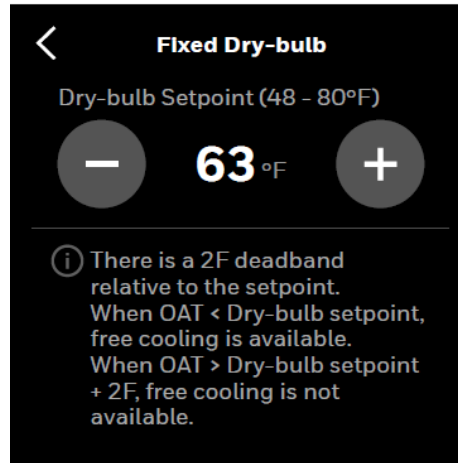
28. Tap **Shutdown** and set Close/Open for damper position shutdown.
- You have successfully configured the internal economizer.

## Criteria

### Fixed Dry-bulb

To use Fixed Dry-Bulb control, the thermostat must have an Outdoor Air (OA) Temperature reading for a connected analog or C7400S Sylk sensor, or have outdoor temperature values sent over BACnet. When OA temperature is below the Dry-bulb Setpoint, the outside air can be used for economizing. When conditions are above the configured set point plus 2 °F differential, conditions are no longer good to economize.

Figure 98 Fixed dry-bulb

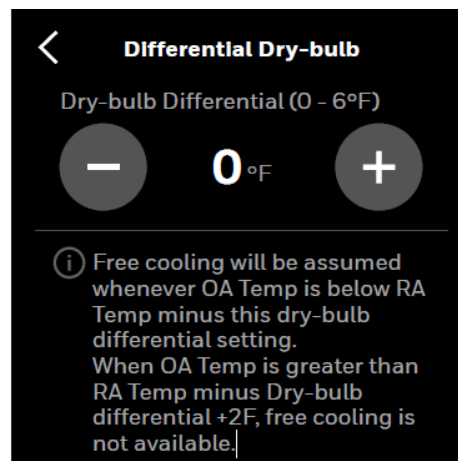


**Note:** Analog dry bulb sensors be used for economizer function when configured for single or dual dry bulb control.

### Differential Dry-bulb

To use Differential Enthalpy control an analog or C7400S Sylkbus sensor must be configured for RA in addition to the OA temperature required for Fixed Dry-bulb control. Differential Dry-bulb control compares the outside air temperature to the return air temperature to determine if the outdoor air is good to economize. Free cooling will be available whenever the OA temperatures below the RA temp by at least the configured Dry-bulb differential. When outdoor air increases by 2 °F above RA - Dry-bulb Differential, the conditions are no longer good to economize.

Figure 99 Differential dry-bulb



### Fixed Enthalpy

To use Fixed Enthalpy control the thermostat must have a C7400S Sylkbus sensor for OA, or have outdoor temperature and humidity values sent over the BACnet. The thermostat calculates the enthalpy and dew point using the OA temperature and humidity values. Fig.77 shows the Fixed Enthalpy boundaries in the internal economizer of the thermostat. There are 5 boundaries (setpoints ES1 through ES5),

which are defined by dry bulb temperature, enthalpy and dew point. Refer to Table 20 for the ENTH CURVE setpoint values. When the OA temperature, OA humidity and OA dew point are all below the selected boundary, economizing is available. When conditions are above the selected boundary, the conditions are not good to economize.

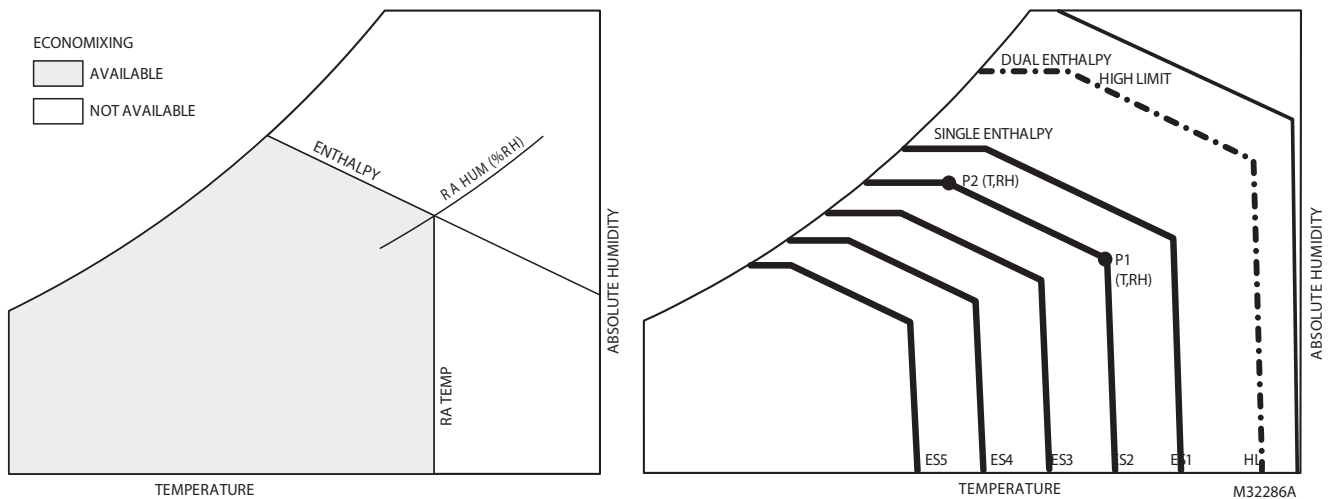
**Differential Enthalpy**

To use Differential Enthalpy control a C7400S Sylkbus sensor must be configured for RA in addition to the OA required for Single Enthalpy. Differential Enthalpy control compares the outside air conditions to the return air conditions to determine if the outdoor air is desirable for economizing. There is also a high limit boundary for differential enthalpy. The high limit boundary is ES1 when there are no stages of mechanical cooling energized and HL when a compressor stage is energized.

**Table 22: Single Enthalpy and Dual Enthalpy High Limit Curves**

Enthalpy Curve	Temp. Dry-Bulb (°F)	Temp. Dewpoint (°F)	Enthalpy (btu/lb/da)	Point P1		Point P2	
				Temp. °F	Humidity %RH	Temp. °F	Humidity %RH
ES1	80.0	60.0	28.0	80.0	36.8	66.3	80.1
ES2	75.0	57.0	26.0	75.0	39.6	63.3	80.0
ES3	70.0	54.0	24.0	70.0	42.3	59.7	81.4
ES4	65.0	51.0	22.0	65.0	44.8	55.7	84.2
ES5	60.0	20.0	60.0	46.9	51.3	88.5	
HL	86.0	66.0	32.4	86.0	38.9	72.4	80.3

**Figure 100** Single and Dual Enthalpy curve and boundaries



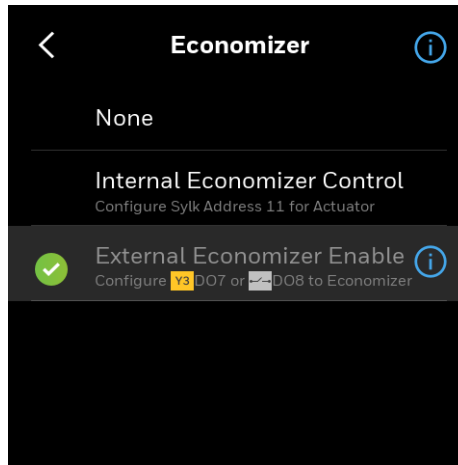
## Enabling the external economizer

This section contains the procedure to enable the external economizer. Use this option if economizer sensors and actuators are connected to an additional economizer module. Be sure to make necessary economizer enable and alarm connections between the thermostat and economizer module.

### To configure the external economizer

1. Swipe left from the Home page.
2. Tap **Config** > scroll down > **Advanced** > **Equipment** > scroll down > **Economizer**.  
The Economizer page appears.

**Figure 101** External economizer home page



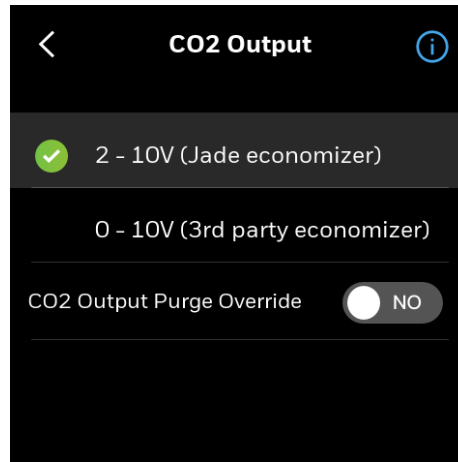
3. Tap **External Economizer Enable**.  
If the DO7 and DO8 are not configured for the external economizer then a banner message appears.
4. Tap **YES** to configure the I/Os.
5. Configure the DO7 and DO8.
6. Navigate back to the Economizer page and tap **External Economizer Enable**.

### Optional Configuration for Enhanced Operation of External Economizer:

A CO2 sensor can be configured via Sylk or UI to measure CO2 at the thermostat and provide high limit alert. CO2 Output can be configured on UIO2 to send CO2 signal to the external economizer to provide DCV functionality. CO2 Output from the TC500 must be connected to CO2 Input on the economizer.

7. To configure CO2 output, tap **Config** > scroll down > **Advanced** > **Configurable I/O** > **UIO2** > scroll down > **CO2 Output**.

Figure 102 CO2 output



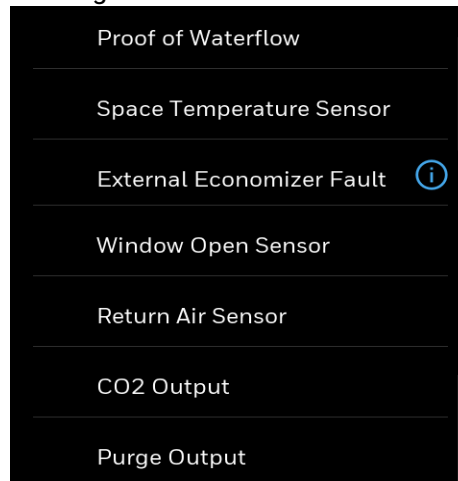
8. Select the economizer type that is connected to the thermostat.

### Configuring the external economizer fault detection

External economizer fault can be configured as follows: add economizer input from the Economizer to UI of TC500 and configure a UI input for External Economizer fault. External Economizer fault will not be reported if not configured

9. To configure, tap **Config** > scroll down > **Advanced** > **Configurable I/O** > **UIO1** > scroll down > **External Econ Fault**.

Figure 103 External econ fault



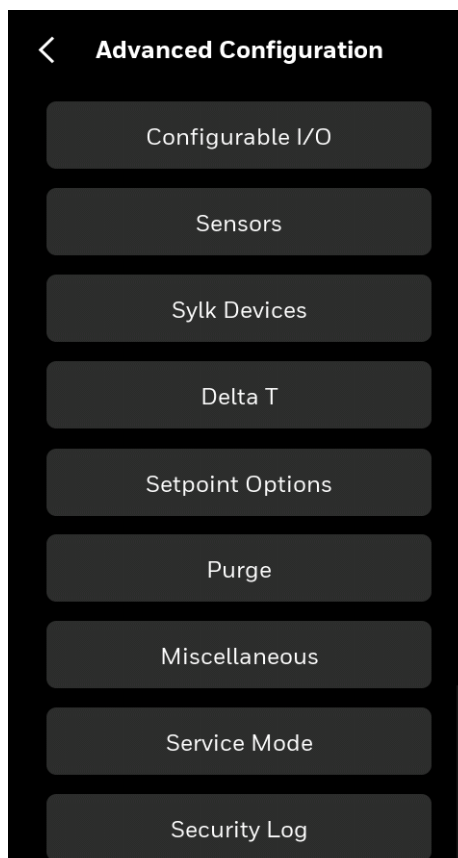
## Advanced configuration

The Advanced configuration page displays all the advanced options of the thermostat.

1. Swipe left from the Home page.
2. On the Quick access page, tap **Config** > **Advanced**.  
The Advanced configuration page appears.



Figure 104 Advanced configuration



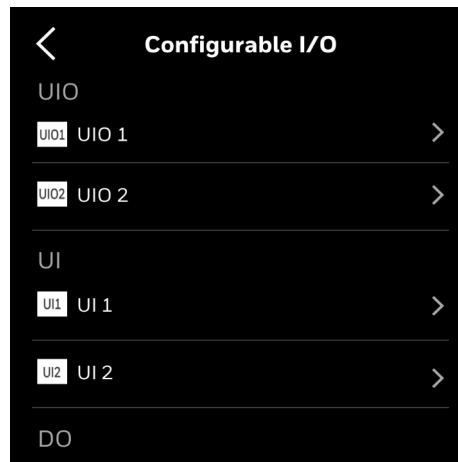
## Configuring the thermostat I/O terminals

After connecting the thermostat to equipment, you must configure certain terminals in the thermostat so it can identify the correct purpose and apply the appropriate control schemes. The Configurable I/O tab provides options configure thermostat to the equipment and sensors wired to it. For more information on terminal assignments, refer to [Terminal assignment](#) on page 24.

### To view and configure the I/O

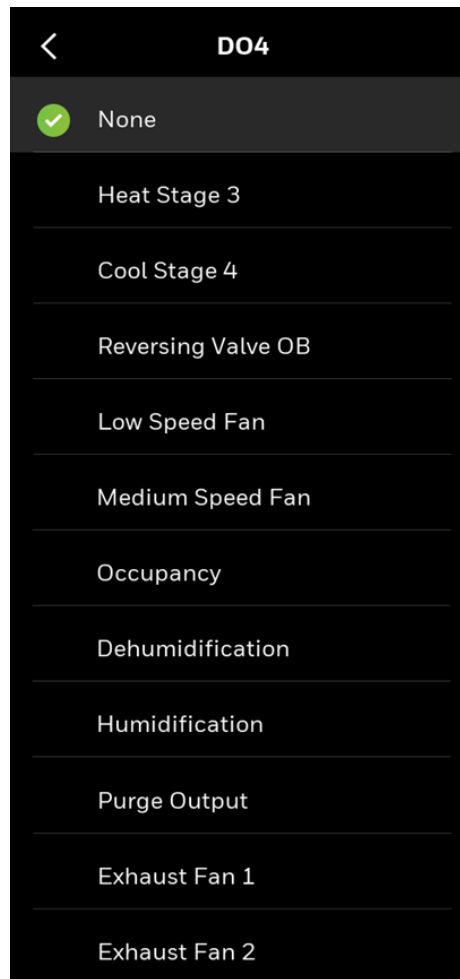
1. Swipe left from the Home page.
2. Tap **Config** > scroll down > **Advanced** > **Configurable I/O**.  
The Configurable I/O page appears. Scroll down to see more I/Os.


Figure 105 Terminals page



- Some terminals such as DO2, DO3, DO5, and DO6 show the equipment configured in the corresponding terminals and are not configurable by the user.
- If the mixed air and outdoor air sensor are configured as Sylk sensors, when the users configure analogs on the UIO1, UIO2, UI1, and UI2, the user will be notified to disconnect the Sylk sensor, and the Sylk configuration will be turned off.
- Users can configure DO4, DO7, and DO8 for the exhaust fans. Exhaust Fan1 must be selected to select Fan2. Even though Fan1 and Fan 2 are configured under different DOs, Fan1 must be selected first to use Fan2.

Figure 106 Typical exhaust fan assignment on DO4



3. For other terminals, tap the particular terminal.  
Associated equipment terminals appears. Scroll down to see more equipment.
4. Tap an equipment terminal.  
The selected terminal is connected with the thermostat.
5. Tap the back button   
You can see the selected equipment terminal is assigned on the Configurable I/O page.

## Configuring the sensors

Thermostat supports Sylk devices, Control sensors (temperature and humidity only), and four additional sensors. In order to ensure proper operation and control, configure for Sylk devices only if they actually will be wired to the TC500.

**Local Sensor:** Internal TC500 temperature sensor. Installer can configure offsets to onboard temperature and humidity sensors, if desired.

**Remote Sensor:** Space temperature sensor connected to UI/UIO terminal, TR40 wall module configured at address 2, or TR120 wall module configured at address 6.

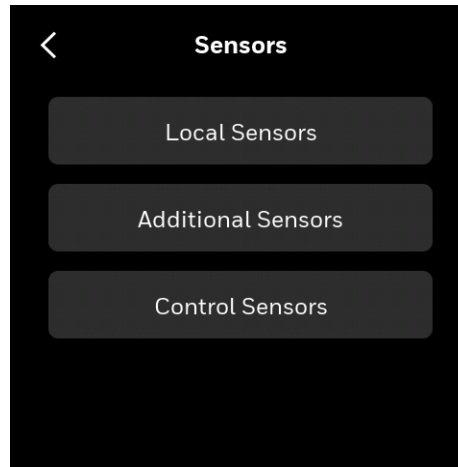
**Multi Sensor:** Local Sensor and Sylk wall module at address 2, 3, 4, 5, 6 used together to calculate space temperature.

If the thermostat is located in the occupied space and system is using a remote temperature sensor, it is recommended to use the “smart” or “average” sensor options. In the event of remote sensor failure the temperature will be controlled using the onboard sensor in the thermostat. When using averaging the thermostat's onboard sensor should be set at minimum level 1 weighted setting.

### To configure the sensors

1. Swipe left from the Home page.
2. Tap **Config** > scroll down > **Advanced** > **Sensors**.  
The Sensors page appears.

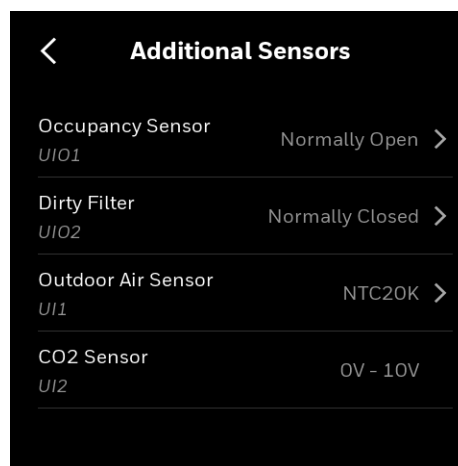
Figure 107 Sensors



3. Tap **Local Sensors**.
4. Tap **Temperature Sensor Offset** and set the temperature limits.
5. Tap **Humidity Sensor Offset** and set the humidity level.
6. Tap the back button and navigate back to the Sensors page to save the settings.
7. Tap **Additional Sensors**.

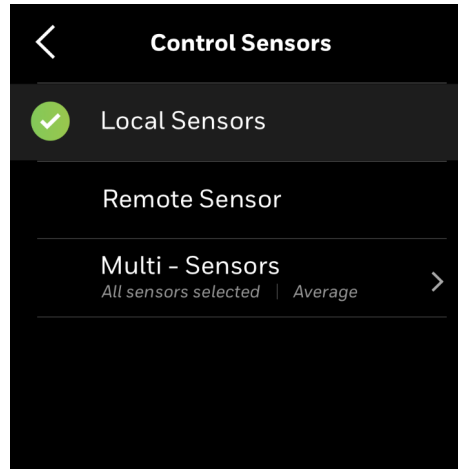
The Additional Sensors page appears that lists 4 sensors, only if already configured in UI01, UI02, UI1, and UI2 terminals of the thermostat. Otherwise, the “No Additional Sensors Here” message appears.

Figure 108 Additional sensors



8. Navigate back to the Sensors page and tap Control Sensors.  
The Control Sensors page appears. By default, it shows **Local Sensors**. If Remote sensors are also configured then **Multi-Sensors** and **Remote Sensors** also appear.

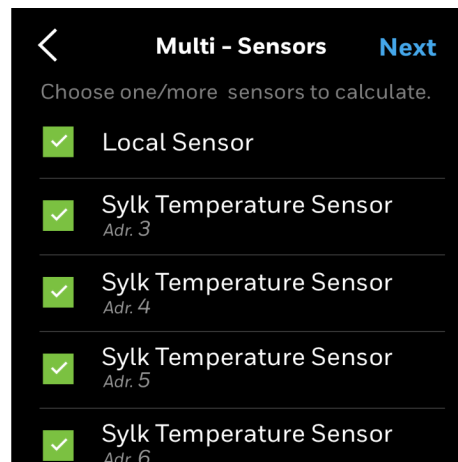
Figure 109 Control sensors



The Multi-Sensors tab allows you to configure certain parameters of multiple sensors at a time.

9. Tap **Multi-Sensors**.  
The Multi-Sensors page appears. It lists all the control sensors that are configured with the thermostat. Scroll down to see more sensors.

Figure 110 Multi-sensors

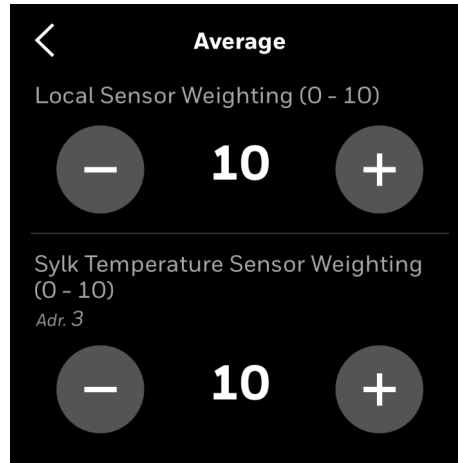


10. Select the required sensors for calculation.  
11. Tap **Next**.

The Calculate Sensors page appears. It lists,

**Average** - The weighted average of the sensors is used for control. Tap the right arrow to set the relative weight of each sensor.

Figure 111 Average options



Values show the relative weighting for each sensor in temperature averaging. The built in logic calculates weighted average as the assigned sensor weighting times the measured temperature for each sensor and divides by the total weighting. When a sensor is not connected, the effective weight for that sensor is 0, and therefore excluded from the calculation. When a sensor is connected, the effective weight can be adjusted from 0-10, with the default being 10.

Scroll down to view Adr. 4 and Adr 5. Tap the back button to navigate back to the Calculated Sensors page.

**Minimum** - The minimum sensed temperature is used for control and displayed as the indoor temperature.

**Maximum** - The maximum sensed temperature is used for control and display.

**Smart** - When the TC500 is in the heating mode, the minimum sensed temperature is used. When in the cooling mode, the maximum sensed temperature is used. When in neither in heating or cooling mode, the average space temperature is used.

12. Tap one of the above-given parameters.  
The corresponding parameter page appears with the list of selected sensors. Scroll down to see more sensors.
13. Adjust the values by tapping plus or minus signs.

## Configuring the Sylk devices

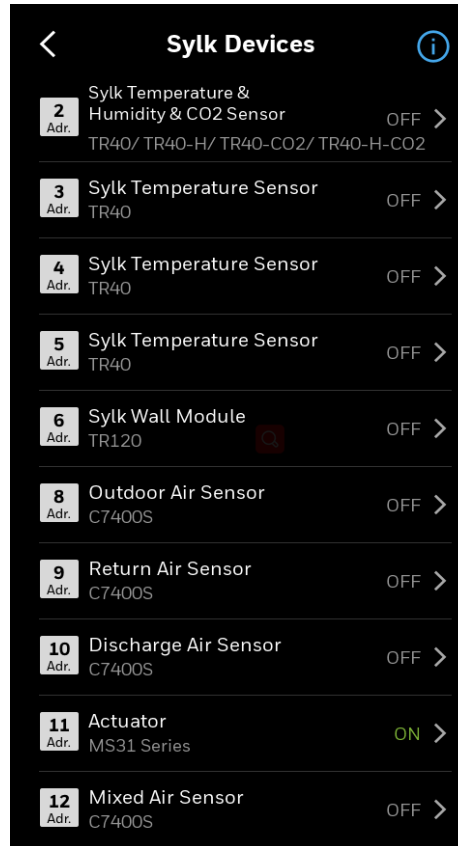
Make sure that the required sylk devices are connected to the thermostat.

### To configure the Sylk devices

1. Tap **Config** > **Advanced** > **Sylk Devices**.

A list of Sylk devices appear with the respective bus address corresponding to the address number listed in the thermostat listing.

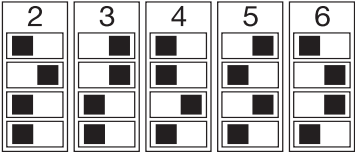
**Figure 112** Sylk devices



**Note:** The total number of Sylk Devices is restricted by Power and Communication bandwidth. In general, the number of Sylk devices cannot exceed (1) Actuator plus (3) Sensors (only one of which can be TR120 or a CO2 sensor). Contact the Honeywell Technical Support team for additional support.

2. Tap the right arrow of the device to view the dip switch picture.

**Table 23: Sylk device dip switches**

Sylk Address	Device Type	Sensors	DIP Switches
2	Sylk Temperature & Humidity & CO2 sensor	TR40/ TR40-H/ TR40-CO2/ TR40-H-CO2	
3	Sylk Temperature sensor	TR40	
4	Sylk Temperature sensor	TR40	
5	Sylk Temperature sensor	TR40	
6	Sylk Wall Module	TR120	
8	Outdoor Air Sensor	C7400S	
9	Return Air Sensor	C7400S	
10	Discharge Air Sensor	C7400S	
12	Mixed Air Sensor	C7400S	
11	Actuator	MS31 Series	Refer to relevant actuator installation instructions.

3. Turn on the sensors.



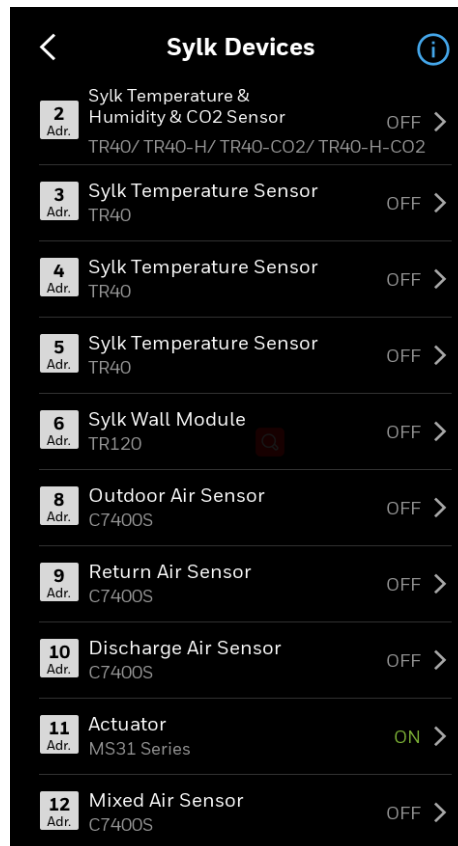
## Activating the Sylk actuator

Sylk actuator must be activated to use the internal economizer feature. Make sure that the actuator is connected to the thermostat before configuring it.

### To activate the Sylk actuator

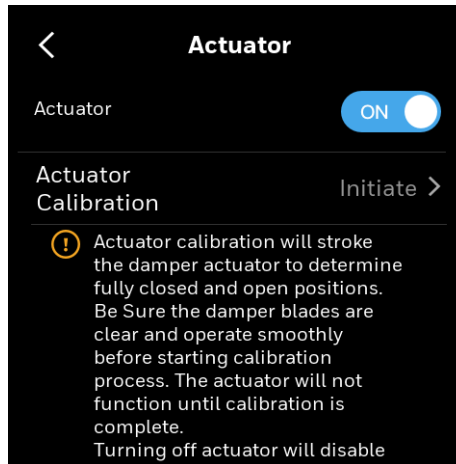
1. Tap **Config > Advanced > Sylk Devices**.  
The Sylk Devices page appears.

Figure 113 Sylk devices



2. Scroll down and tap **Actuator**.  
The Actuator page appears.
3. Turn on the Actuator by sliding the button to right.

Figure 114 Actuator

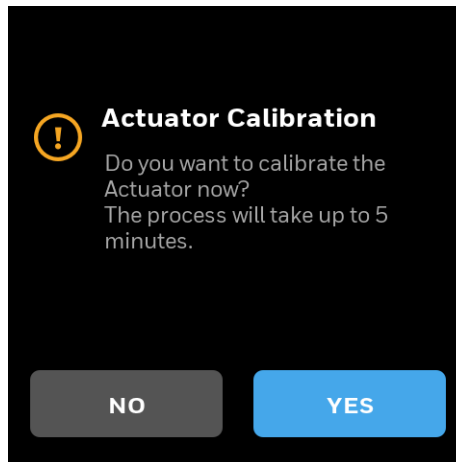


Actuator calibration will stroke the damper actuator to determine fully closed and open positions. Be sure the damper blades are clear and operate smoothly before starting the calibration process. The actuator will not function until calibration is complete. Once complete the calibrated min. and max. positions will be displayed. The thermostat will scale the actuator signal between these min. and max. positions to eliminate nuisance faults if the damper rotation is less than 90 degrees.

4. Tap **Initiate**.

The Actuator Calibration confirmation message appears.

Figure 115 Calibration confirmation message

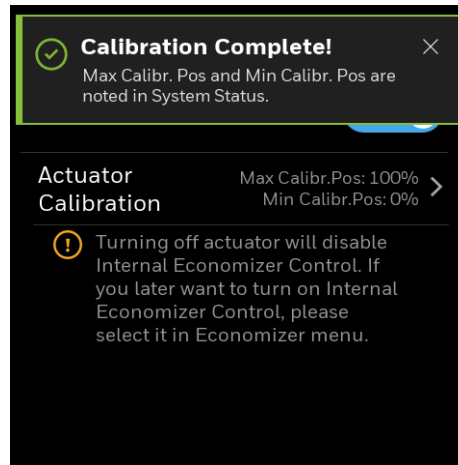


5. Tap **YES**.

The actuator calibration begins. It configures **Close/Holding**, **Driving to Min**, **Open/Holding**, and **Driving to Max** damper positions.

If all configurations are favorable, the Calibration Complete message appears.

Figure 116 Actuator calibration complete



You can see **Max Calibr. Pos: 100%, Min Calibr. Pos 0%** information on the screen. If you want to recalibrate again, tap the right arrow.

If the calibration is failed, then you can see **Fault** on the screen. Tap the right arrow to do calibration again.

**Note:** *If you remove power to the actuator then the internal economizer will be turned off.*

## Configuring Delta T Diagnostics

Delta T (Difference in temperature) is a diagnostic tool that measures the temperature increase across the heating coil or decrease across the cooling coil using readings from the connected Discharge Air and Mixed Air sensors. User considers their Target Delta T measurement and configures a range (Min and Max) and Alarm Delay time to avoid nuisance alarms. Status and Alarm will indicate the Target Delta T range, Absolute Delta T measurement, and High or Low compared to target to assist in troubleshooting. There are two levels of alarms indicating severity from Target Delta T. Orange level alarm indicates Delta T is out of range by less than 5 °F. Red level alarm indicated Delta T is more than 5 °F out of range.

Configuration of Delta T requires:

- Discharge Air and Mixed Air analog or Syk sensors are configured. Return Air or Room sensor can be used in place of Mixed Air if Internal Economizer is not configured.
- External economizer not used in the system. When an external economizer is used the thermostat does not have direct control of mechanical cooling and cannot provide proper diagnostics.

Example Delta T calculations:

Cooling: If Discharge Air is 52°F and Mixed Air is 70°F, Delta T is 18°F.

Heating: If Discharge Air is 125°F and Mixed Air is 70°F, Delta T is 55°F.

### Related topics

[Configuring the thermostat I/O terminals](#)

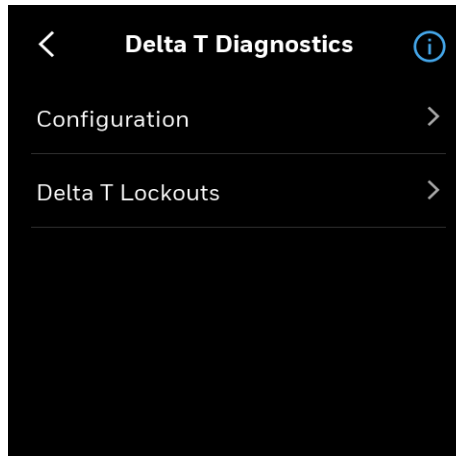
[Viewing the system status](#)

[Managing Delta T alarms](#)

### To configure the Delta T settings for the equipment

1. Swipe left from the Home page.
2. Tap **Config** > scroll down > **Advanced** > **Delta T Diagnostics**.  
The Delta T Diagnostics page appears.

Figure 117 Delta T diagnostics



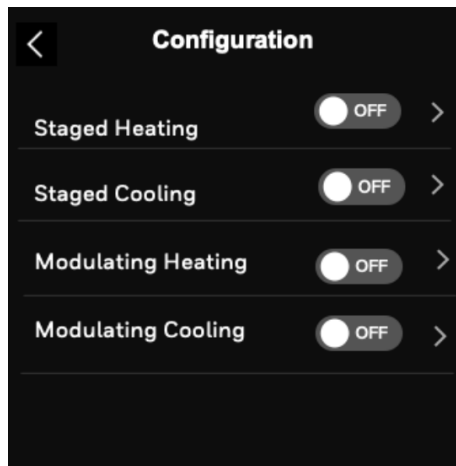
3. Tap the information icon to understand the Delta T functionality.
4. Tap **Configuration**.  
The configuration page appears.  
This page is dynamic, options displayed vary according to the equipment selection.  
There is two possible combinations of equipment selection and Delta T configuration varies accordingly.

### Delta T configuration for the staged equipment

Heating and Cooling stages are available. For example, if the equipment is staged equipment and you want to configure Delta for staged cooling.

5. Tap **Configuration**.  
The configuration page appears with available configured equipment type.

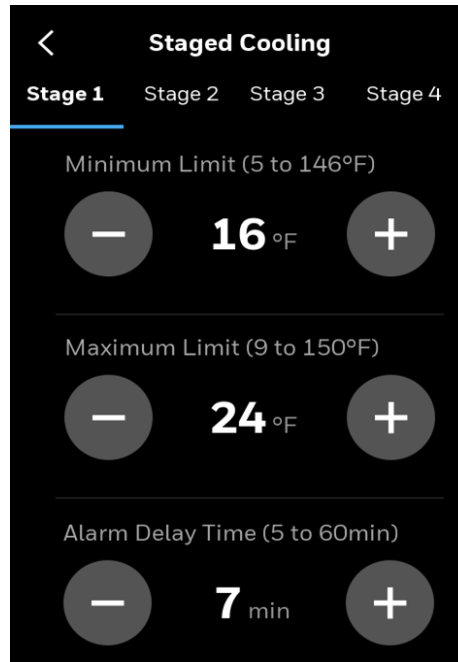
Figure 118 Staged equipment - Delta T configuration



- Tap **Staged Cooling**.  
The Staged cooling page appears.

**Note:** *Minimum and Maximum limits are the desired fault limits for differential temperature between Discharge Air and Mixed Air sensors. Alarm will trigger according to the configured limits and time delay. These can be configured for each stage independently, if desired.*

**Figure 119** Delta T configuration - Staged cooling



#### Delta T configuration for the modulating equipment

Modulating heating and modulating cooling are available. For example, if the equipment is modulating equipment and you want to configure Delta for modulating heating.

- On the Configuration page, tap **Modulating Heating**.  
The Modulating Heating page appears.

Figure 120 Delta T configuration - Modulating heating

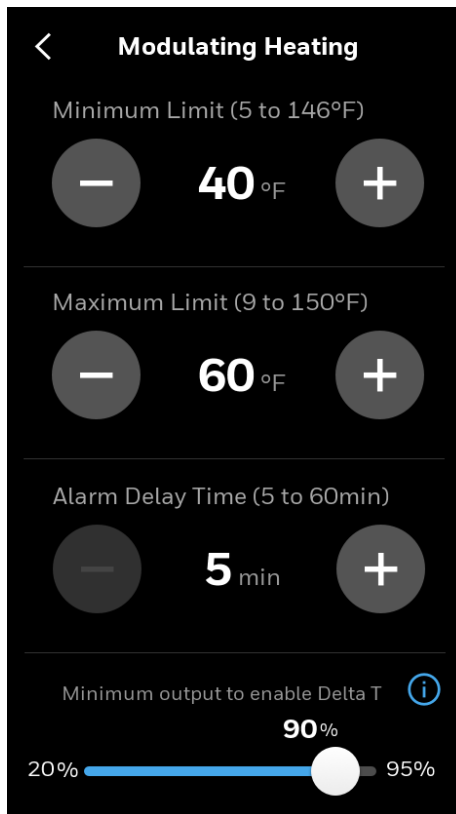
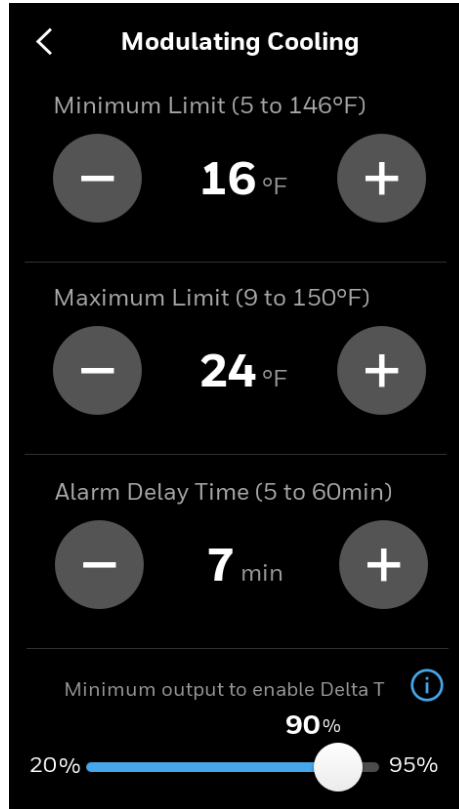
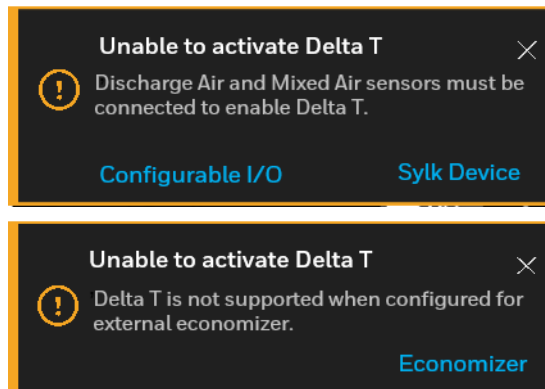


Figure 121 Page for Modulating cooling



**Note:** You may get *Unable to activate Delta T* message due to missing of Discharge air and Mixed air sensors or thermostat configured for external economizer. You can tap the hyper link buttons on the notification to navigate to the required pages for the configuration.

Figure 122 Unable to activate Delta T



Delta T uses MA as priority. If MA is configured, MA will be used. If MA is not configured and RA is configured, RA will be used. If MA and RA are not configured, Room temp will be used. Priority is MA > RA > Room.

Table 24: Delta T configuration

Equipment Type	Configuration Type	Configuration Select	Alarm Limit Range	Default value
Conventional with modulating heating	Staged heating	Stage 1/Stage 2/ Stage 3	Minimum Limit (5 - 146°F)	40°F
			Maximum Limit (9 - 150°F)	60°F
			Alert Delay Time (5- 60 min)	5min
	Staged cooling	Stage 1/Stage 2/ Stage 3	Minimum Limit (5 - 146°F)	16°F
			Maximum Limit (9 - 150°F)	24°F
			Alert Delay Time (5- 60 min)	7min
	Modulating heating (Not applicable if modulating heating is not configured)	NA	Minimum Limit (5 - 146°F)	40°F
			Maximum Limit (9 - 150°F)	60°F
			Alert Delay Time (5- 60 min)	5min
			Minimum output to enable Delta T	70%
	Modulating cooling (Not applicable if modulating cooling is not configured)	NA	Minimum Limit (5 - 146°F)	16°F
			Maximum Limit (9 - 150°F)	24°F
Alert Delay Time (5- 60 min)			7min	
Minimum output to enable Delta T			70%	
Heat pump with modulating heating	Compressor heating	Stage 1/Stage 2/ Stage 3	Minimum Limit (5 - 146°F)	16°F
			Maximum Limit (9 - 150°F)	24°F
			Alert Delay Time (5- 60 min)	7min
	Compressor cooling	Stage 1/Stage 2/ Stage 3	Minimum Limit (5 - 146°F)	16°F
			Maximum Limit (9 - 150°F)	24°F
			Alert Delay Time (5- 60 min)	7min
	Auxiliary heating (Not applicable if Auxiliary heating is not selected)	Stage 1/Stage 2	Minimum Limit (5 - 146°F)	40°F
			Maximum Limit (9 - 150°F)	60°F
			Alert Delay Time (5- 60 min)	5min

**Notes:**

- The number of stages of heating/cooling varies based on the number of stages configured during the equipment selection.
- You can set the minimum and maximum limits of heating and cooling by tapping “+” or “-” icons.
- There should be minimum 4°F between Minimum and Maximum. Example, if set range is 16 to 20, if user changes minimum to 17°F, maximum will automatically be changed to 21°F. If user changes max from 21 back to 20, minimum will automatically change to 16°F.



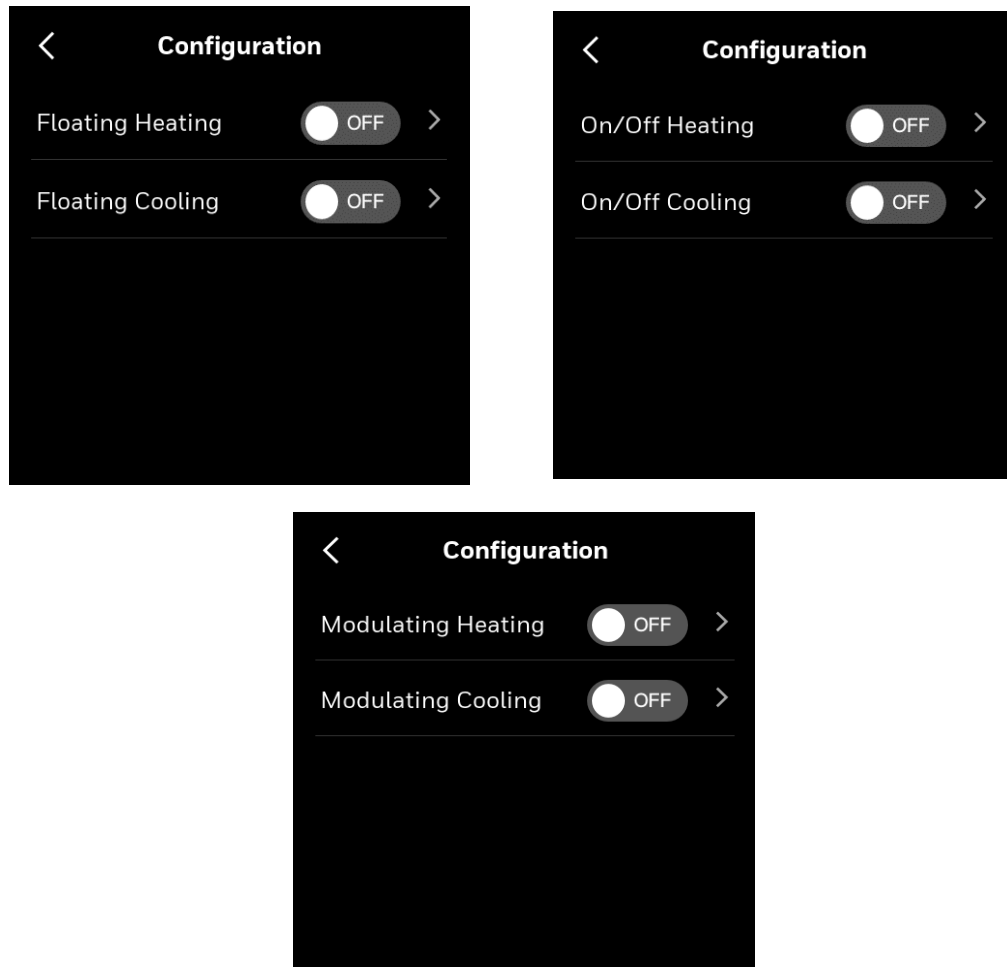
- The default delay time for heating is 5 minutes, and for cooling is 7 minutes.

### Delta T configuration for the fan coil (Floating, On/off, Modulating equipment)

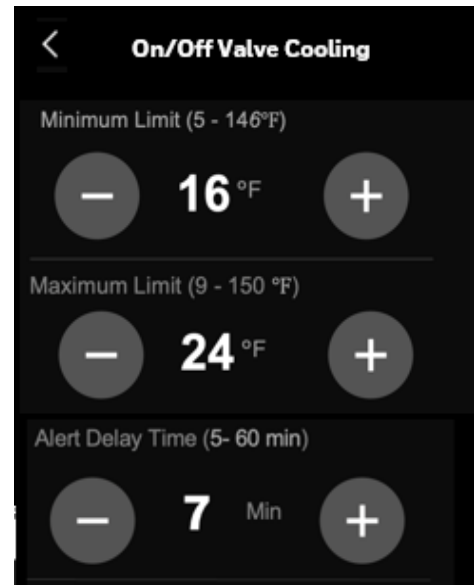
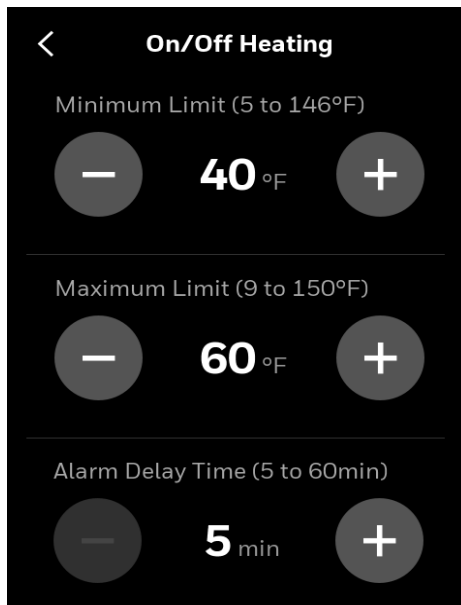
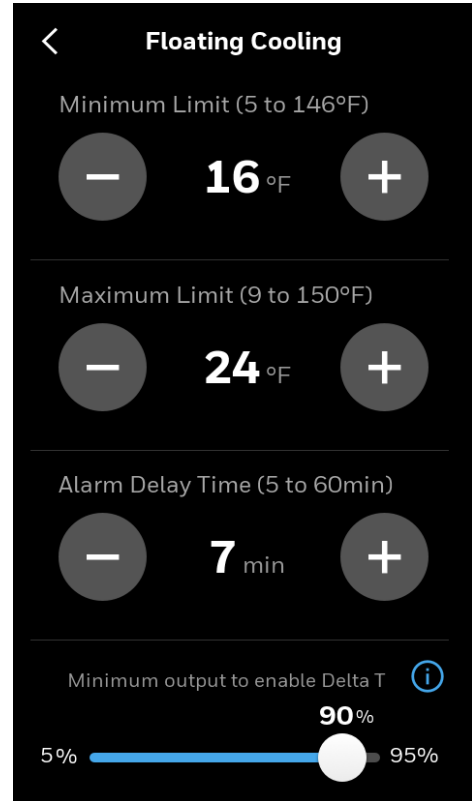
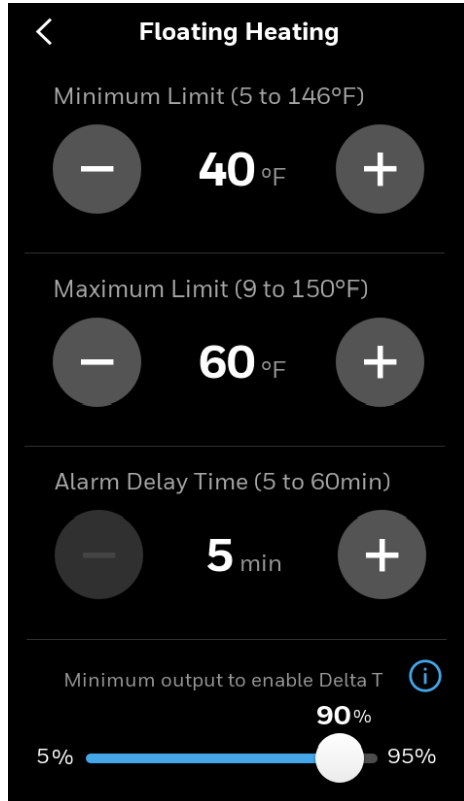
If the equipment is fan coil then the following Delta T configurations are available.

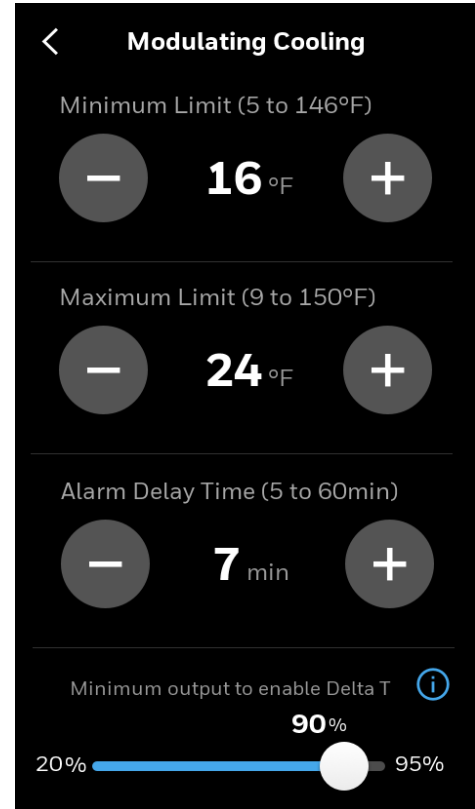
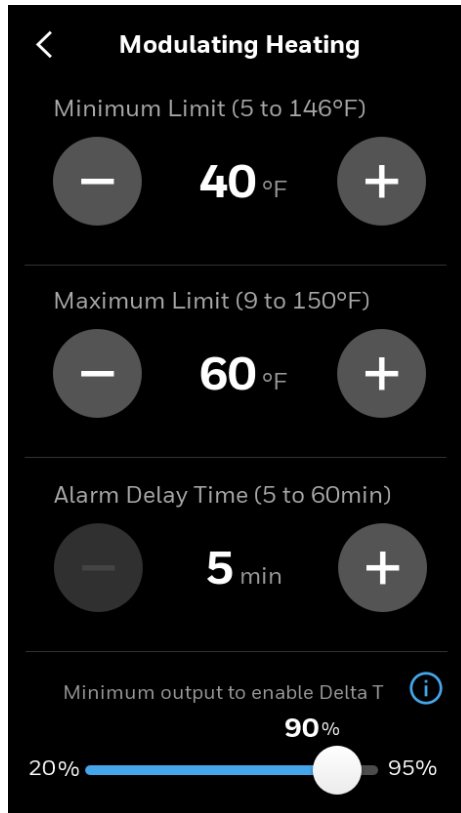
- Floating heating/Floating cooling or
- On/Off valve heating or On/Off valve cooling or
- Modulating cooling/Modulating heating

**Figure 123** Delta T configuration for fan coil equipment



1. Enable the configuration and tap the right arrow button to set the parameters,





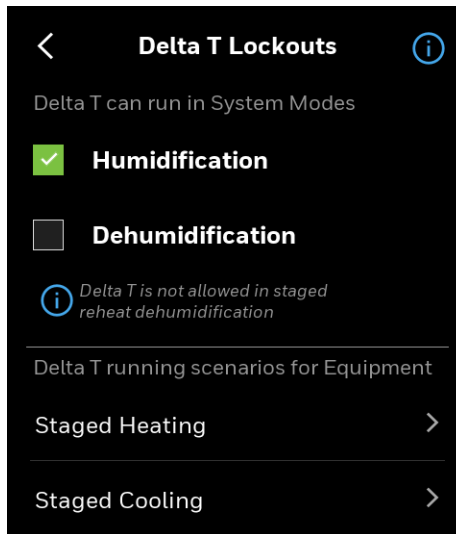
## Delta T Lockouts

Delta T lockouts provide settings to suppress nuisance alarms during non-optimal outdoor and mixed air conditions. Settings are available to allow/disallow Delta T alerts during Humidification and Dehumidification.

### To access Delta T Lockouts

1. On the Delta T page, tap **Advanced Options**.  
The Delta T Lockouts page appears.

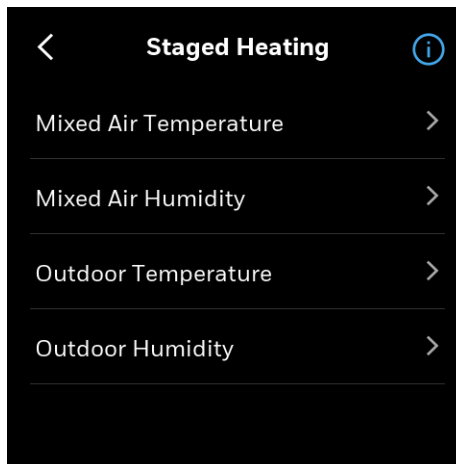
Figure 124 Delta T lockouts



**Note:** *Delta T function is not allowed for systems using Hot Gas Reheat for dehumidification*

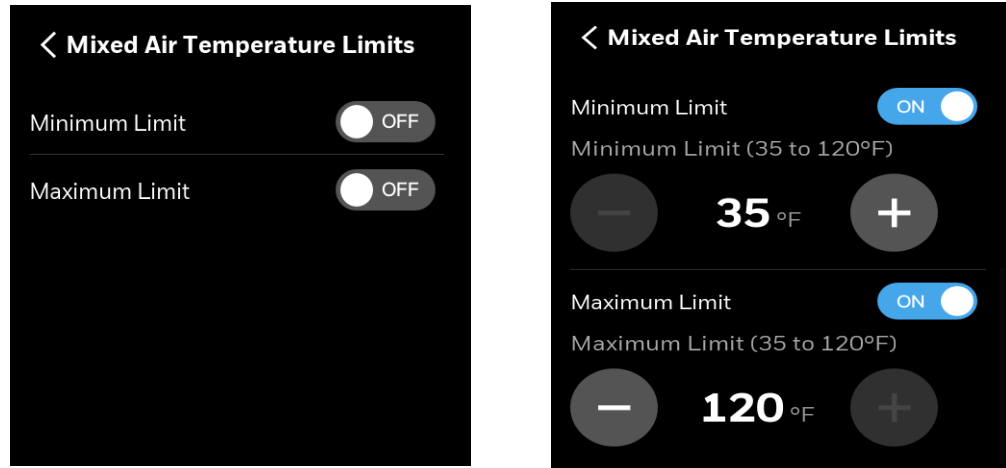
2. Select the **Humidification** and **Dehumidification** checkboxes to run the Delta T in humidification and dehumidification modes.  
 Only the MA humidity & temperature and OA humidity & temperature of the configured equipment are displayed. You can see the following equipment if configured.
  - Staged Heating
  - Staged Cooling
  - Modulating Heat
  - Modulating Cool
  - Compressor Heating
  - Compressor Cooling
  - Auxiliary Heating
3. If Conventional staged heating is configured, tap **Staged Heating**  
 The Staged Heating page appears.

Figure 125 Staged heating



4. Tap **Mixed Air Temperature**.  
The Mixed Air Temperature Limits page appears.

**Figure 126** Mixed air temperature limits



**Note:** The limits are off by default.

5. Set the limits.
6. Set the limits for **Mixed Air Humidity**, **Outdoor Temperature**, and **Outdoor Humidity**.  
Once the values are set, the Delta T will be operated within the limits.
7. Repeat the same operation for other equipment.

## Managing setpoint options

This option allows users to set the maximum or minimum temperature setpoints.

### To manage the setpoints of the equipment

1. Swipe left from the Home page.
2. Tap **Config** > scroll down > **Advanced** > **Setpoint Options**.  
The Setpoint Options page appears. It provides the following heating or cooling options.

**Table 25:** Setpoint Options

Operation	Configuration Type	Range	Description
Stops	Cooling Min. Setpoint	50-99°F (Default 50°F)	The minimum cool setpoint that can be set by the user
	Heating Max. Setpoint	40-90°F (Default 90°F)	The maximum heat setpoint can be set by the user

Table 25: Setpoint Options

Operation	Configuration Type	Range	Description
Limits	Thermostat Deadband	2°F-8°F(Default: 3°F)	The thermostat Deadband ensures that the heat setpoint and the cool setpoint maintain a temperature span this number of degrees when the thermostat is in auto mode.
	Temporary Setpoint Limit	0°F - 30°F (Default 30°F)	The temporary setpoint adjustment allows an occupant to change the space temperature setpoint during occupied periods. This includes scheduled occupancy or override of the scheduled occupancy (bypass override). During unoccupied and standby periods, the effective setpoint offset is set to 0 Δ°F. If an occupant wants to change the temporary setpoint, the occupant must first override the schedule to occupied and then the thermostat will allow the occupant to change the temporary setpoint
Cooling Recovery	Max. Setpoint Ramp	0 -20°F/hr (Default 6°F/hr	When an outside air temperature is available, the effective cool ramp rate is changed as the outdoor air temperature changes. When the outdoor air temperature is at the minimum cool ramp rate temperature (e.g. 90°F) and above, the effect cool ramp rate is at the minimum cool ramp (e.g. 2 Δ°F/hr). When the outdoor air temperature falls, the cool ramp rate is lowered until the maximum cool ramp temperature (e.g. 70) is reached or above, the effective cool ramp is at the maximum cool ramp rate (e.g. 6 Δ°F/hr). The cooling recovery algorithm is well established over decades of use and is the same as used on the T7350 and similar Honeywell commercial thermostat models.
	Min. Setpoint Ramp	0 -20°F/hr (Default 2°F/hr]	
	OAT at max. Cool setpoint Ramp	-40 -120°F (Default 70°F)	
	OAT at min. Cool setpoint Ramp	-40 -120°F (Default 90°F)	
Heating Recovery	Max. Setpoint Ramp	(0 -36°F/hr)	When an outside air temperature is available, the effective heat ramp rate is changed as the outdoor air temperature changes. When the outdoor air temperature is at the minimum heat ramp rate temperature (e.g. 0°F) and below, the effect heat ramp rate is at the minimum heat ramp (e.g. 2 Δ°F/hr). When the outdoor air temperature is at the maximum heat ramp temperature (e.g. 60°F) and above, the effective heat ramp is at the maximum heat ramp rate (e.g. 8 Δ°F/hr). The heating recovery algorithm is well established over decades of use and is the same as used on the T7350 and similar Honeywell commercial thermostat models.
	Min. Setpoint Ramp	(0 -36°F/hr)	
	OAT at max. Heat setpoint Ramp	-40-120°F (Default 60°F)	
	OAT at min. heat setpoint Ramp	-40-120°F (Default 0°F)	

## Configuring Purge

The Purge function is used to rapidly flush the building air volume using high percentage of outdoor air just prior to or immediately after occupancy to improve the indoor air quality.

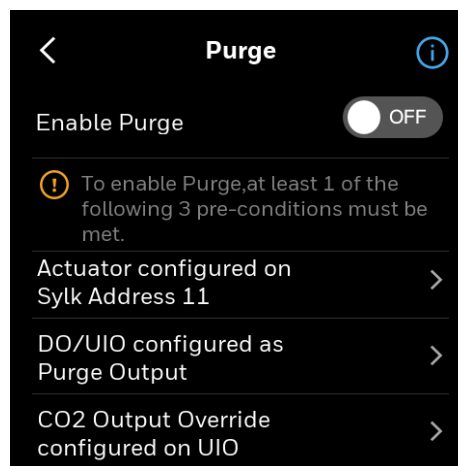
This function can be enabled after activating at least one of the following three conditions.

1. Actuator configured on Sylk Address 11  
To enable, **Config > Advanced > Sylk Devices > Actuator**. Turn on the actuator. Configuring the thermostat to use the connected Sylk actuator for purge allows the used to configure the fan speed and damper position for purge events. This option should be used for applications where the damper actuator is connected directly to the thermostat, such as the Internal Economizer function.
2. DO/UIO configured as Purge Output  
To enable, **Config > Advanced > Configurable I/O > UIO1/UIO2/DO4/DO7/DO8 > scroll down > Purge Output**.  
Configuring a DO/UIO for purge output will active the output during purge events. The user will also be able to configure the fan speed during purge. This option should be used with an external economizer or RTU control board that has an input for purge.
3. CO2 Output configured to override during purge  
To enable, **Config > Advanced > Configurable I/O > UIO1/UIO2 > scroll down > CO2 Output**. Slide the CO2 Output Purge Override button to **YES**.  
This option requires a CO2 sensor to be wired to the thermostat on a UI/UIO or the Sylk bus and is intended for use with the Honeywell JADE(tm) or other external economizer with DCV input. During normal operation the configured CO2 output a signal proportional to the current CO2 value. The output will be overridden to max value during a purge event commanding the external economizer to drive the damper to the maximum ventilation position. Note: The time it takes to drive to vent max position depends on the ramp timing built into the external economizer.

### To configure purge

1. Swipe left from the Home page.
2. Tap **Config > Advanced > scroll down > Purge**.  
The Purge page appears.

Figure 127 Purge

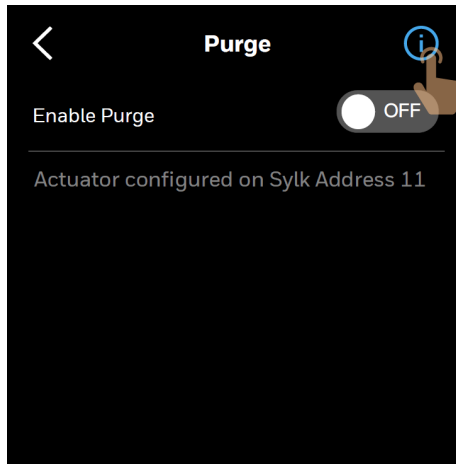


3. Tap the Information icon to read and understand the Purge functionality and its pre-condition.  
You can enable the purge only if at least one of the pre-condition is configured.  
If all conditions are enabled then they will appear on the screen.

**If the pre-condition “Actuator configured on Sylk Address 11” is configured.**

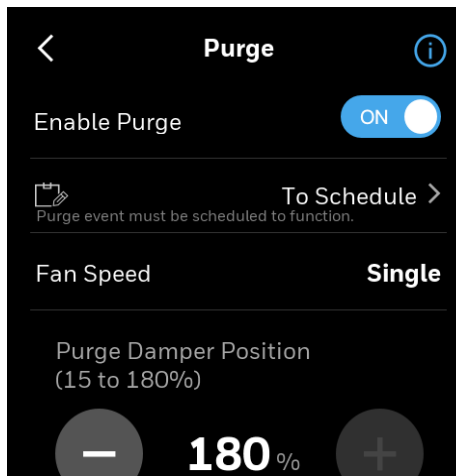
The pre-condition appears on the screen. If all pre-conditions are configured then all messages appear on the screen. This option is used when TC500 is performing economizer function

**Figure 128** Pre-condition 1



4. Tap the information icon to read the description of the pre-condition. If multiple pre-conditions are configured then you can see descriptions of all pre-conditions.
5. Enable the Purge by sliding the **Off** button to **ON**.  
The Purge page appears.

**Figure 129** Actuator configured on Sylk address 11



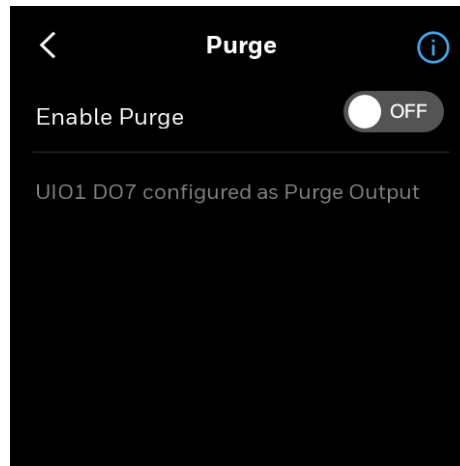
6. Tap **To Schedule** to schedule the purge cycle. Refer to [Setting up a weekly schedule](#).
7. After Purge scheduling is configured, on the Purge screen, tap **Fan Speed**, and select **High** or **Low**. If it is a variable speed fan, then select a speed of the fan.



**If the pre-condition “DO/UIO configured as Purge Output” is configured.**

The pre-condition 2 appears on the screen. It displays all terminals that are configured as Purge out. This option is applicable when external economizer controller is being used in system.

**Figure 130** Pre-condition 2

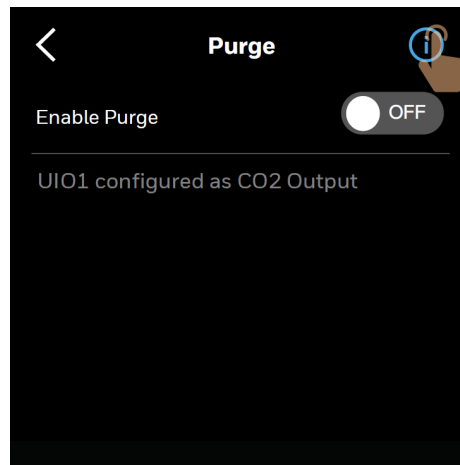


8. Repeat from Step 4 to Step 7.

**If the pre-condition “CO2 Output configured for Purge” is configured.**

The pre-condition 3 appears on the screen. It displays all terminals that are configured as Purge out. This option is applicable when external economizer controller is being used in system.

**Figure 131** Pre-condition 3



9. Repeat from Step 4 to Step 7.

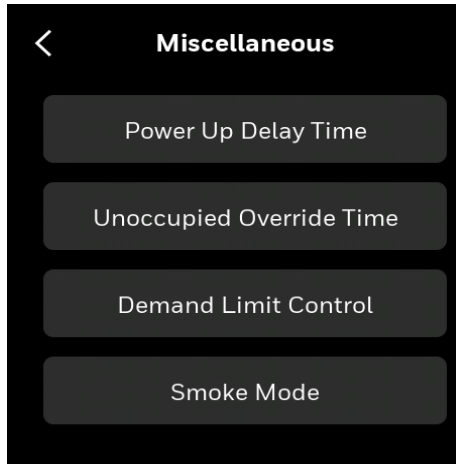
## Miscellaneous

This section contains miscellaneous feature that manages the thermostat functionalities.

**To manage the thermostat’s miscellaneous functions**

1. Swipe left from the Home page.
2. Tap **Config** > scroll down > **Advance** > scroll down > **Miscellaneous**.  
The Miscellaneous page appears.

**Figure 132** Miscellaneous



**Table 26: Miscellaneous**

Operation	Configuration Type	Range	Description
Power Up Delay Time	Controller delay after power up	0 – 300 s (Default 10s)	Following power-up for this amount of time, the fan, heating, and cooling outputs are disabled. This is to prevent multiple controllers from starting major electrical loads simultaneously when power is restored to a building.
Unoccupied Override Time	Duration	1-1080 mins (Default 180 mins)	Number of minutes the TC500 will switch from unoccupied to occupied in override
Demand Limit Control	Setpoint Shift	+/- 0 – 10°F (Default 3°F)	The number of degrees that the controller can shift the setpoint to shed load upon request from the utility using a network command. Demand response is triggered via a BACnet connection.

Table 26: Miscellaneous

Operation	Configuration Type	Range	Description
Smoke Mode (Smoke Mode is triggered by a BACnet command)	No action	No action is taken (Default)	
	Shutdown	Turn all outputs OFF (fan, heating and cooling stages and humidification are off)	Shutdown can be initiated by digital input on UI1, UI2, UIO1 or UIO2 or as part of the BACnet Smoke Mode network command.
	Pressurize	Fan is turned on	If an outdoor air damper is set under Configurable I/O and wired to the thermostat, the damper will be driven open in the Pressurize and Depressurize modes.
	Depressurize	Fan is turned on	

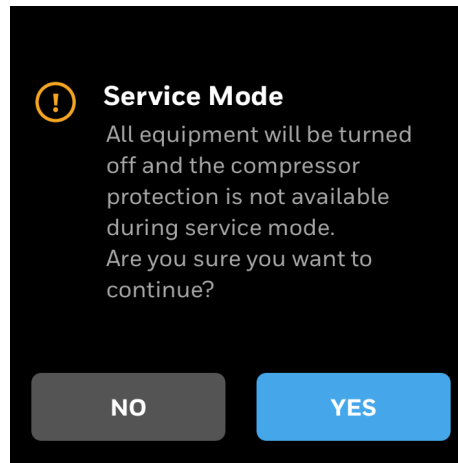
## Enabling the Service mode

Service mode disables all control algorithms to perform service of the equipment. Compressor protection is not available during the service mode.

### To enter service mode

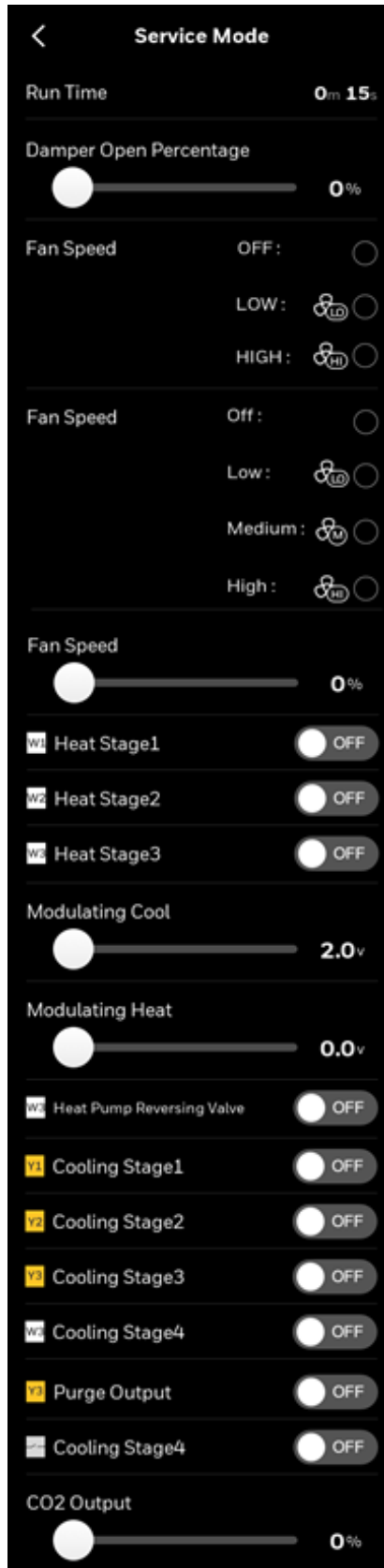
1. Swipe left from the Home page.
2. Tap **Config** > scroll down > **Advanced** > scroll down > **Service Mode**.  
The service mode caution message appears.

Figure 133 Service mode caution page



3. Read the message, and tap **Yes** to continue.  
The Service Mode page appears.

Figure 134 Service mode



4. Tap each item to see the current values and status.
5. Tap the back arrow button to exit the service mode and resume the equipment operation and control algorithms.

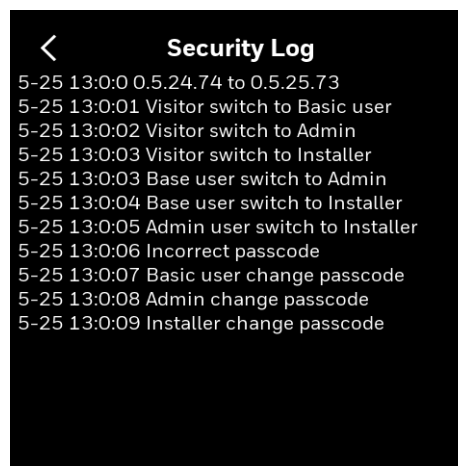
## Viewing the Security log

The security log contains records of the critical security events such as password change, user role switch, firmware upgrade and so on.

### To view the security log

1. Swipe left from the Home page.
2. Tap **Config** > scroll down > **Advanced** > scroll down > **Security Log**.  
The Security log page appears.

Figure 135 Security log



## Managing the thermostat connection

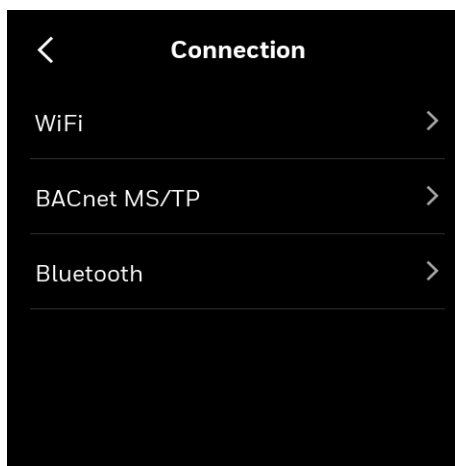
The thermostat is connected with Wi-Fi while performing the initial configuration. The source of the Wi-Fi can be Local router, Honeywell Gateway, or BACnet IP. Bluetooth is used to register the thermostat with the Connect Mobile and Connect Me apps.

The Wi-Fi can be enabled/disabled at any point of time. Disabling Wi-Fi will result in the following actions. Thermostat will be restarted, Bluetooth and ADR will be disabled, communication with Gateway and Mobile app will be suspended, and BACnet IP communication will be disabled. Only Admin and Installer can enable/disable Wi-Fi.

### To connect with Wi-Fi

1. Swipe left from the Home page.
2. On the Quick access page, tap **Config** > **Connection**.  
The Connection page appears.

Figure 136 Connection page



### Wi-Fi - Local Router

1. Tap **Wi-Fi** > slide the **Enable WiFi** button to **ON** > **Local Router**, and tap **NEXT**.  
A list of the Wi-Fi signals available in the surroundings appears
2. Select a secured Wi-Fi signal and tap **NEXT**.  
The Wi-Fi Password page appears.
3. Tap **Join**.  
Wi-Fi connection progress appears, followed by the Successful message appears.
4. Close the Successful message.  
The Config page appears.

### Wi-Fi - Honeywell Gateway

If you are using Honeywell Gateway, then you can connect the thermostat to it.

1. Tap **Wi-Fi** > slide the **Enable WiFi** button to **ON** > **Honeywell Gateway**, and tap **NEXT**.
2. Tap **Automatic** to connect with the Gateway automatically. It automatically searches the Gateway Wi-Fi station and connect with it.
3. Tap **Manual** and tap **NEXT**. It ask you to enter the Gateway Wi-Fi credentials to manually connect with the Gateway.  
The Manual page appears.
4. Enter **SSID** and select **Security**, tap **NEXT**.  
Wi-Fi connection progress appears, followed by the Successful message appears.
5. Close the Successful message.  
The Config page appears.

### BACnet IP

**Note:** If you are using BACnet IP connection type, then you cannot communicate with the Occupant app.

1. Tap **Wi-Fi** > slide the **Enable WiFi** the button to **ON** > **BACnet IP**, and tap **NEXT**.
2. Tap BACnet Network Settings to connect through local network or tap Wi-Fi.
3. Enter **Device ID**, **Network Number**, **UDP Port**, and tap **NEXT**.

4. Tap DHCP for automatic assigning of the IP address or tap Static manually enter the IP address and Subnet Mask.
5. Tap **NEXT**.  
The Wi-Fi Scanning page appears followed by successful connection message.

**Note:** For BACnet object related information, refer to the 31-00478-01(BACnet Integration Guide - TC500A).

### BACnet MS/TP

1. Tap **Config > Connection > BACnet MS/TP**.  
The BACnet MS/TP page appears.
2. Tap **BACnet MS/TP**, enable the BACnet MS/TP.
3. Enter a unique Device ID for the thermostat. It should be different from other TC500A thermostats.
4. Auto-MAC addressing is enabled by default, Installer can also manually set a unique MAC address for the TC500A.
5. The device automatically adapts to the baud rate of the MS/TP network. You can also manually select the Baudrate.
6. To change the MS/TP setting, navigate back to BACnet MS/TP page and tap BACnet/MS/TP settings. Refer to BACnet Integration Guide (31-00478).  
TC500A doesn't simultaneously support BACnet IP and BACnet MS/TP. When switching the connection between BACnet IP and BACnet MS/TP, TC500A will give a prompt, then restart automatically.  
TC500A will try to adapt to the Baudrate of the MS/TP network in the first 4 minutes after startup or MS/TP is enabled. If no Baudrate could be determined, for example, there is a single device on the network, then TC500A will choose the default Baudrate of 76800. After that, the Installer can manually change it to another value.
7. Tap **SAVE**.

### Bluetooth

1. If you are pairing your mobile with the thermostat, then tap **Bluetooth**.  
The Bluetooth page appears.
2. Turn on the Bluetooth.  
A pop message appears to enable Wi-Fi, if the Wi-Fi is disabled.
3. Tap **YES**.  
A QR code image appears.
4. Scan the QR code using your mobile.

## User management

The TC500A supports four kinds of user identities. Here's an overview of the identity types and permissions available for various roles.

1. Visitor: The visitor has access to read-only the components associated with the visitor. The visitor can view room temperature, desired temperature, humidity and mode.

**Note:** *when in Simplified view type, if permitted, the visitor will be able to regulate the desired temperature. Basic User, Admin, and Installer require a passcode if utilized. Permission values can be customized for Basic and Admins.*

2. Basic User: The Basic User has access to read and write to components associated with basic control such as Setpoint changes, screen brightness, as configured in the User Management set up section. This type of user role is applicable for the user requiring limited control of thermostat such as store clerks, receptionist.
3. Admin: Group Owner has access to read and write all components related to advance control. The Admin will be able to perform system overrides, schedule changes, or modify the basic configuration. This type of user role is applicable for users requiring more control of the thermostat such as store manager, business owner.
4. Installer: This is an Admin User who has access to read and write all components in the application. Through this role, the user can control all elements of the thermostat.

**Table 27: User Roles and Permissions**

	Visitor	Basic User	Admin	Installer
System Modes		✓	✓	✓
Overrides		✓	✓	✓
View Alerts		✓	✓	✓
Temperature Units		✓	✓	✓
Contractor Information		✓	✓	✓
Brightness		✓	✓	✓
Schedule Changes			✓	✓
Basic Configuration			✓	✓
System Status			✓	✓
Wi-Fi disable/enable			✓	✓
Advanced Configuration				✓



## Passcode rules

All the user accounts are passcode protected. When creating the passcode, follow the passcode rules given below.

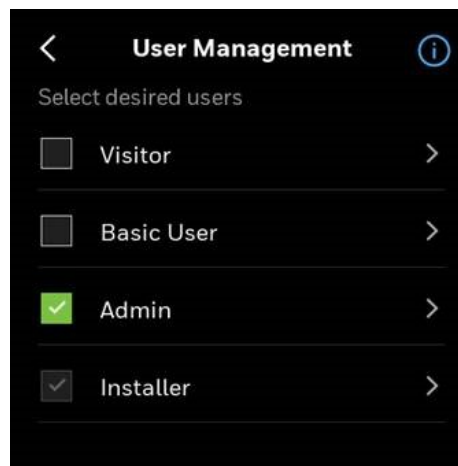
- Passcode length must be between 4 to 12 characters
- Do not use spaces
- Do not use the same passcode used for other users (across all user types)
- If no passcode is entered for basic or Admin, the thermostat will remain at the highest level of access, installer, and will not require a passcode for access.

## Configuring the user roles

### To manage the type of users and permission

1. Swipe left from the Home page.
2. On the Quick access page, tap **Config** > Scroll down > **User Management**. The User Management page appears.

Figure 137 User management



## Visitor

### To manage the Visitor user role


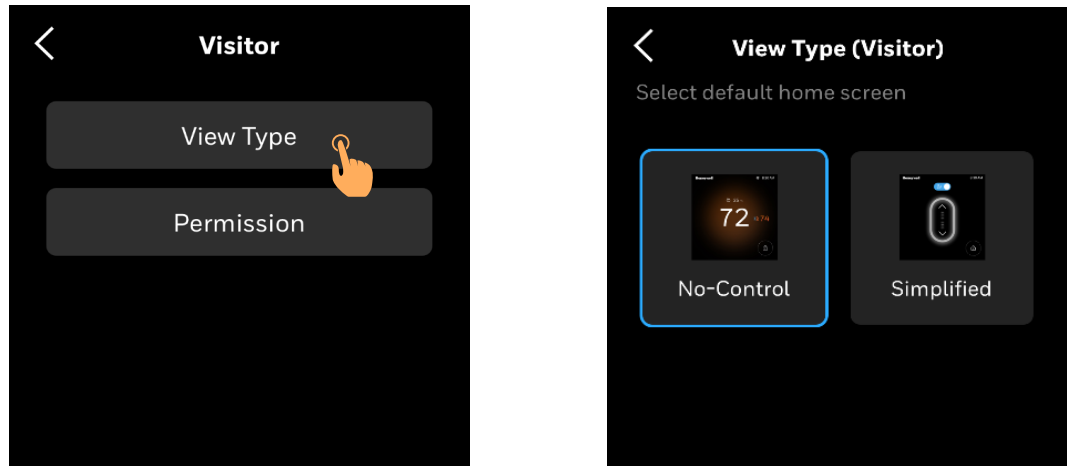
1. On the User Management page, select **Visitor**.  
Tap  to select View Type and Permission
2. Tap View Type.

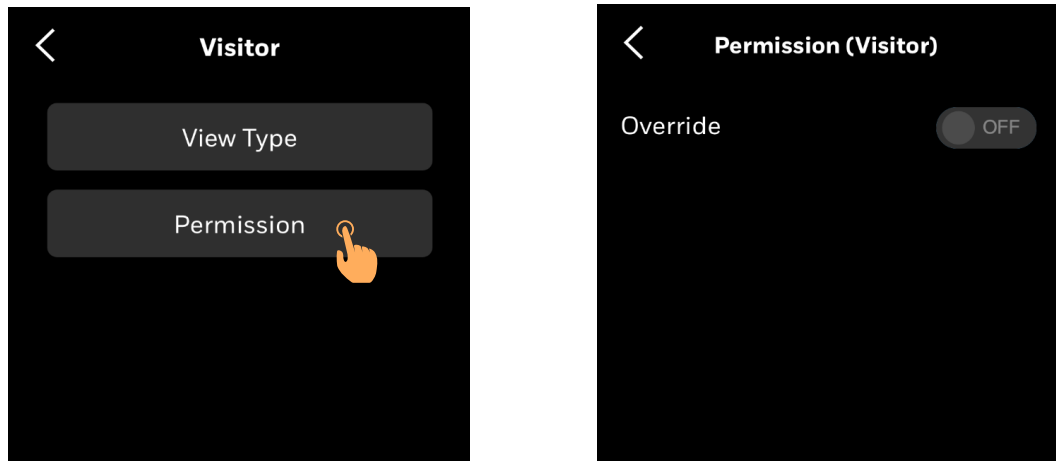
Figure 138 Select view type.





3. Tap Permission to allow the visitor to override the Setpoints.

**Note:** Visitors will have access to increase or decrease the temperature in Simplified view only.

Figure 139 Set visitor permission





4. Tap  to go to the previous page.

Note: After setting these permission or view type and tapping  button, it takes 30 seconds for screen to timeout and sleep. It takes another 30 seconds for the user permission to become effective.

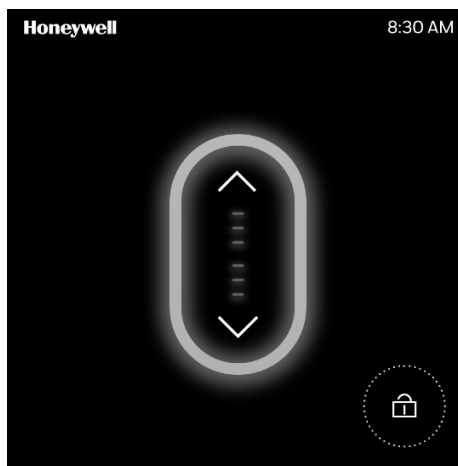
## Simple View Home Screen Controls

The Simple view home screen enables visitors (if permitted) to change the setpoints in occupied or unoccupied mode.

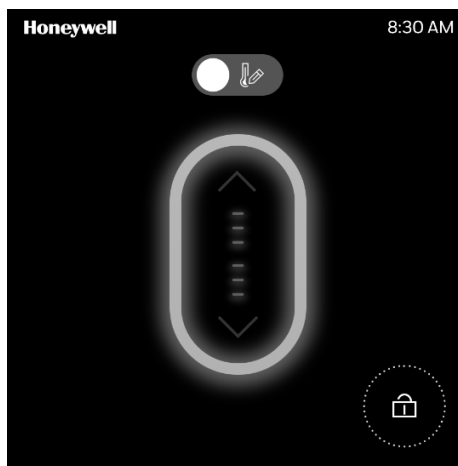
Users can tap  or  to increase or decrease the temperature.

In the unoccupied mode, the simple view has an override toggle option on top. User must slide the toggle to override to make changes in setpoint.

**Figure 140** Simple view - Occupied



**Figure 141** Simple view - Unoccupied





User can tap  or  to increase or decrease the temperature. The thermostat screen provides a visual indication of heating or cooling in different colors. The same is also represented using horizontal bars in the display.

Table 28 Increasing Temperature

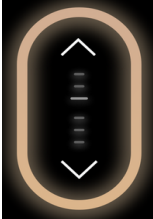


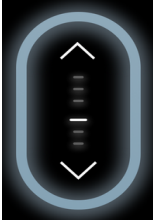



Low	Medium	High
		

Table 29 Decreasing Temperature

Low	Medium	High
		

## Basic user

### To manage the Basic User role

1. On the User Management page, select **Basic User**, and tap 
2. Set a Passcode, View Type and, user Permission. Refer to [Passcode rules](#).

**Note:** The Passcode button appears only if the pass is set for the Basic user.

Figure 142 Basic user

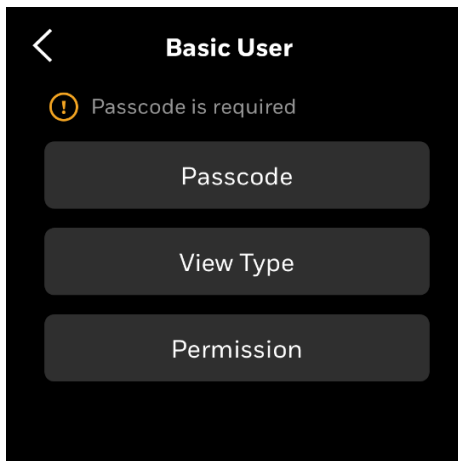
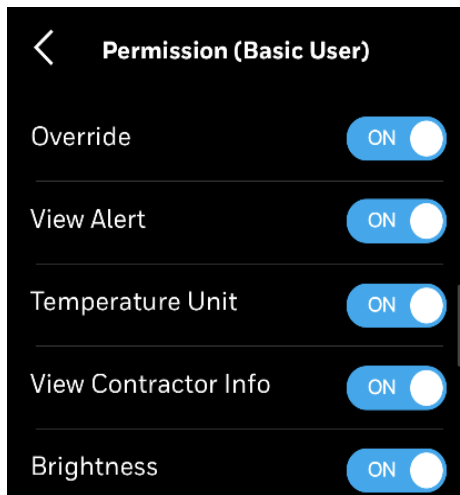
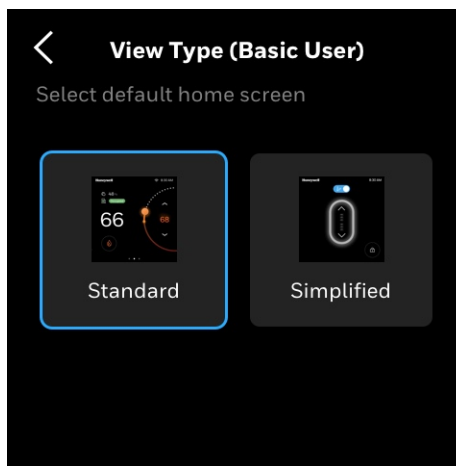


Figure 143 Basic user permission.



3. Toggle the undesired Permissions to “Off” position.
4. Select the View Type.  
Scroll up or down to view additional options.

Figure 144 Select view type




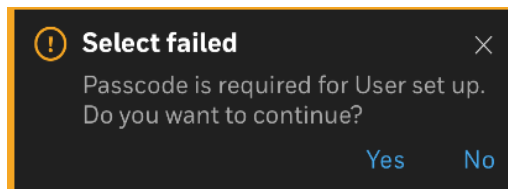
5. Tap  to go to the previous menu.
6. If the passcode is not entered a notification banner appears. Tap Yes to enter the passcode.

Figure 145 No passcode



## Admin

### To manage the Admin role


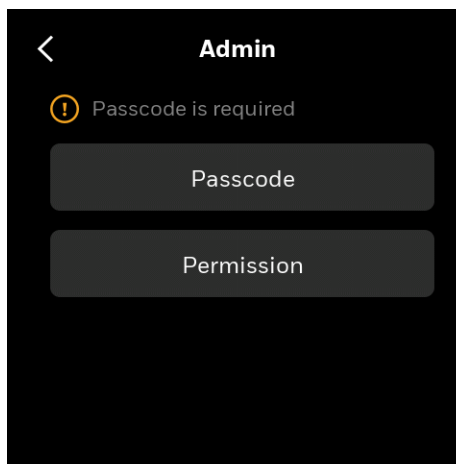
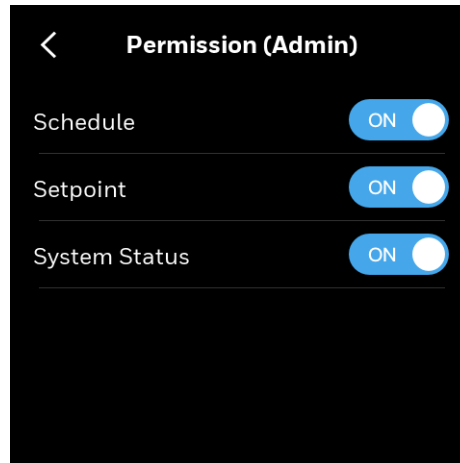

1. On the User Management page, select **Admin**, and tap .
2. Set a Passcode, Permission. Refer to [Passcode rules](#).

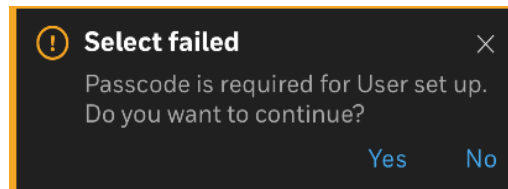
Figure 146 Admin





1. Toggle the undesired Permissions to “Off” position.
2. Tap  to go to the previous menu
3. If the passcode is not entered a notification banner appears. Tap Yes to enter the passcode.

**Figure 147** No passcode



## Installer

### To manage the Installer role


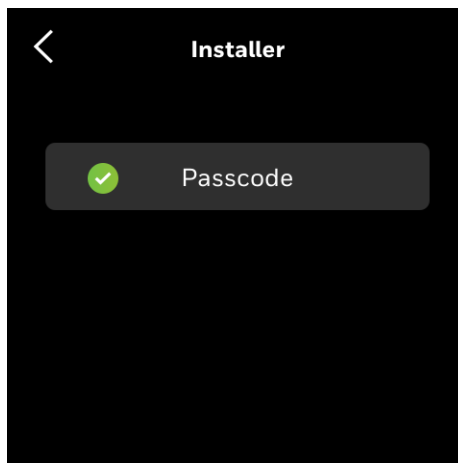
1. On the User Management page, select **Installer**, and tap .
2. Set or change a Passcode, Permission. Refer to [Passcode rules](#).

Figure 148 Installer



## Configuring the alarm preference

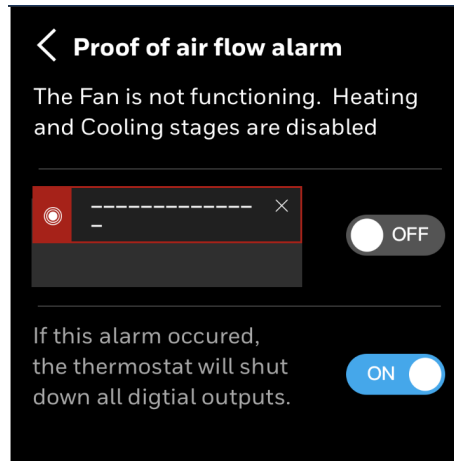
You can configure the alert notification of alarms displayed on the home page of the thermostat. You can choose to display the alerts as a notification banner, or a dot notification based on priority. By default, all alerts are configured to display as a dot notification.

### To set the alert notification preference for alarms

1. Swipe left from the Home page.
2. Tap **Config** > > Scroll down > **Alert Preference**.  
The Alert Preference page appears.
3. Tap **Alarm**.  
A list of alarms option appears.
4. Tap an alarm type.  
Corresponding Alarm settings page appears.
5. Tap the alarm type that you want to configure.  
Corresponding alarm type configuration page appears.



Figure 149 Alarm notification configuration page



6. On the middle row, tap the toggle button to the right to enable the notification settings. The corresponding alarm or reminder type will be displayed as a notification banner on the home page when it is triggered.

## Configuring Auto Demand Response

The Auto Demand Response (ADR) feature is to reduce electricity consumption by raising or lowering setpoint temperatures in response to the Events (peak energy consumption time) provided by utilities in their servers.

The VTN (power grid) servers store the signals of the peak energy consumption as Events. The setback temperature against each event can be configured. These setbacks will be triggered whenever there is a demand to reduce power consumption. The TC500 thermostat is OpenADR compliant.

This section covers

- Configuring the VTN servers
- Configuring setback temperature for Utility events

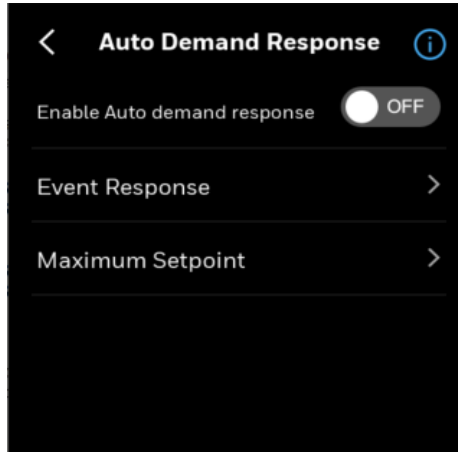
### Prerequisite

A good Wi-Fi connection. To connect with a Wi-Fi network, refer to [To connect with Wi-Fi](#) on page 149.

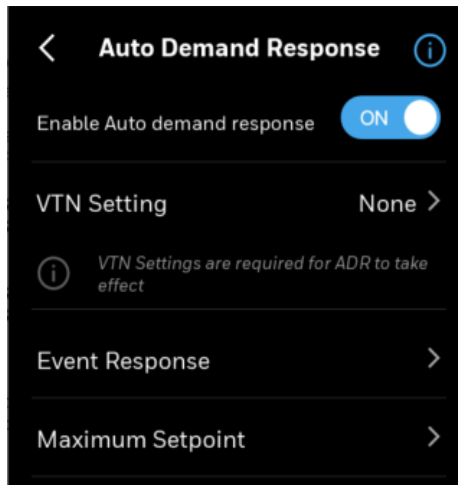
### To configure the auto demand response feature

1. Swipe left from the Home page.
2. Tap **Config** > > Scroll down > **Auto Demand Response**.  
The Auto Demand Response page appears.

Figure 150 Auto demand response main page

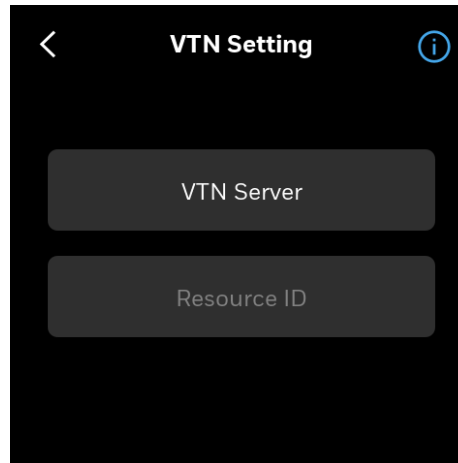


3. Enable the auto demand response by sliding the **OFF** button to **ON**.  
If you are not connected to a Wi-Fi network, then the Cannot Enable ADR pop-up message appears.  
Wi-Fi connection is required to connect with a VTN server.



4. Tap **VTN Setting**.  
The VTN Setting page appears.

Figure 151 VTN settings page

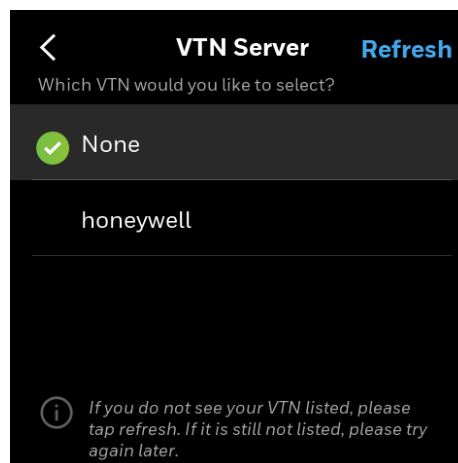


5. Tap **VTN Server**.

A list of VTN servers appears. These servers are fetched from your partner power utility via Honeywell cloud. If no servers appear, tap **Refresh**.

**Note:** Contact Honeywell Customer Support (TAC) for more information on getting VTN servers.

Figure 152 VTN server list

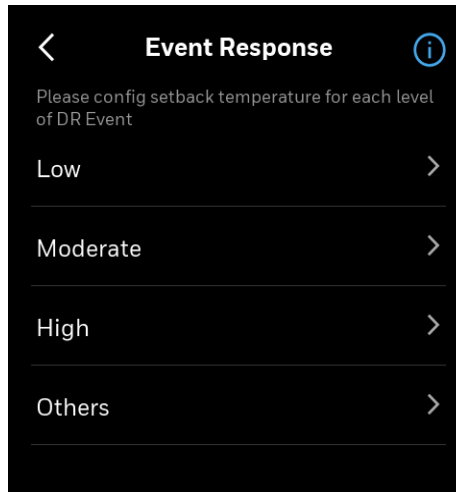


6. Tap the VTN server relevant to your Utility.  
If no VTN is available, tap **Retry** to reload the VTN list.
7. Tap the back arrow button to navigate back to the VTN Setting page.
8. Tap **Resource ID**.  
Enter the resource ID. This number is provided by your Utility. Entering resource ID is optional.
9. Tap the back arrow button to navigate back to the Auto Demand Response page.
10. Tap **Event Response**.  
There are four Event levels available to define in the VTN to accommodate different utility requirements. Low, Moderate, and High Events are default events. In the Others Events tab, relative and absolute setback setpoint values can be configured against simple

events. The Utility will determine the event levels, depending on current energy demand levels. The Utilities may override these response parameters.

Setback for energy saving can be configured for each event level.

**Figure 153** ADR - Events



11. Tap each level and configure the setback. The higher the setback, the greater the energy savings.
12. Tap **Others**.
13. Tap **Relative Setpoint Value** and set the relative value. The amount of temperature setback is relative to the simple events.
14. Tap **Absolute Setpoint Value** and set the absolute heating and cooling setpoints. Absolute setback value will be triggered against the absolute simple events. Each setback will be applied based on the event level triggered by the utility.
15. Tap the back arrow button to navigate back to the Auto Demand Response page.
16. Tap **Maximum Setpoint**.
17. Set the maximum setpoint for the cooling during a demand response event.

## Opt Out ADR

If an ADR event is in progress, then the following operations are prohibited.

- change the setpoint manually
- change the system mode
- override the unoccupied or standby mode

You must opt-out of the ADR to perform the above-given operations.

When trying to perform the above operations, a pop-up notification appears, tap **Detail**, and tap **Opt out**.

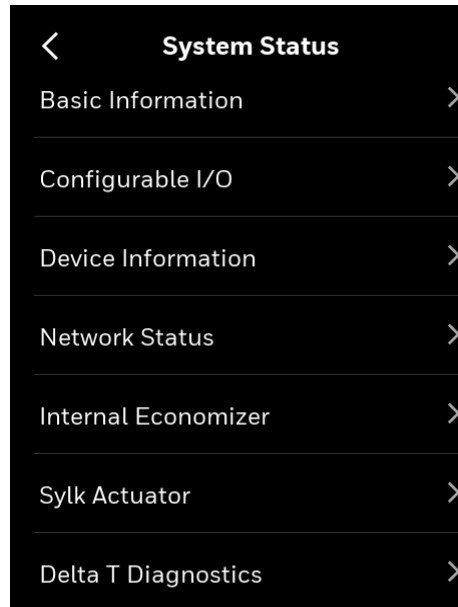
**Note:** You can also tap the ADR icon on the Home page to opt out from the ADR event.

## Viewing the system status

The system status shows device information, live status and readings of the sensors that are operated or connected with the thermostat. These values are view only.

**To view the system status**

1. Swipe left from the Home page.
2. On the Quick Access page, tap **System Status**.  
The System Status page appears.

**Figure 154** System status

3. Tap a required option to view the associated status.

**Table 30: System status**

Basic Information	Displays current Indoor temperature, Indoor setpoint, Indoor humidity, Indoor CO2 level, current system mode, Fan status, Purge, Heat stage status, Cool stage status, Aux heat status, Modulating cool, Modulating heat, Outdoor temperature, Outdoor humidity, Return air temperature (For future release), Discharge air temperature, Economizer enable status, Effective mode, Current state, Next state, Recovery status, Terminal Load, UTC Offset, UTC Time, and Override remaining.
Configurable I/O	All terminals ON/OFF status.
Device information	Model name, Bootloader version, Firmware version, Application version, UUID of the thermostat, Serial number of the thermostat, and QR code to connect with the thermostat using the mobile application.
Network status	Name of the Wi-Fi connected with, Connection status, Wi-Fi MAC address, Wi-Fi SSID, and Wi-Fi IP address of the thermostat.
Internal Economizer	Economizing status, Free cooling available, DCV status, Mixed air min setting, Indoor CO2, Mixed air temp, Outdoor temp, Return air temp, Exhaust Fan1, Exhaust Fan2, Cool stage on, Damper setting position, Damper actual position, Max calibration position, Min calibration position.
Sylk Actuator	Damper actual position, Cycled times in last 24 hours, Running status.
Delta T Diagnostics	Alarm Status, Measured Delta T, Target Delta T, Discharge Air Temp, Mixed Air Temp, Return Air Temp, Indoor Temp, Current Stage, and Current Alarm Delay Time.

**Table 30: System status**

Demand Response	If ADR is ON, tap the right arrow to view the event details or opt out from the ADR.
-----------------	--

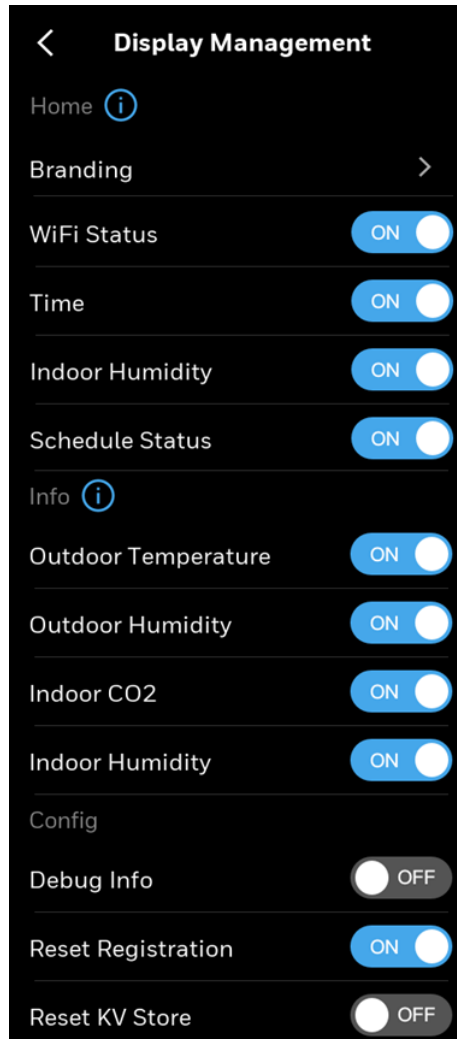
## Configuring the Home page (Display Management)

This section explains managing the icons displayed on the Home page and Ambiance page of thermostat. It is applicable at the device level so any changes on the display management will be applied to all user accounts.

### To manage the display icons

1. Swipe left from the Home page.
2. Tap **Config** >> Scroll down > **Display Management**.  
The Display Management page appears.

Figure 155 Display management



All icons are enabled by default. You can turn it off by sliding the toggle button to the left.

3. Scroll down to see more options.

**Note:** Tap the information icon  to view the icon names.

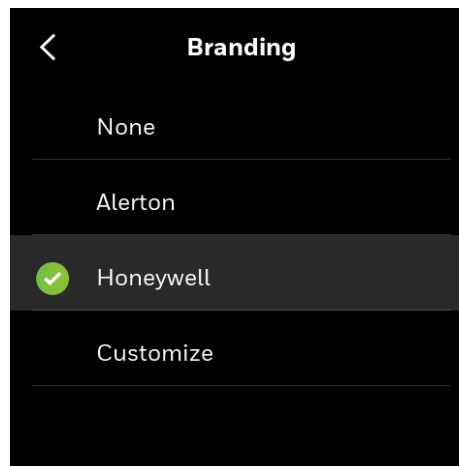
## Branding

The TC500A thermostat is a common device to be supported by multiple brands. The brand name that appears on the home page of the device can be configured to a desired brand name or add a customized name.

### To configure a brand name

1. On the Display Management page, tap **Branding**.  
The Branding page appears.

Figure 156 Branding page



2. Select a desired brand name. Honeywell is the default value. If you tap **None** then there will be no brand name on the home page.
3. If you want to have your customized name instead of a brand name, then tap **Customize** to add a name.

## Reset to Default

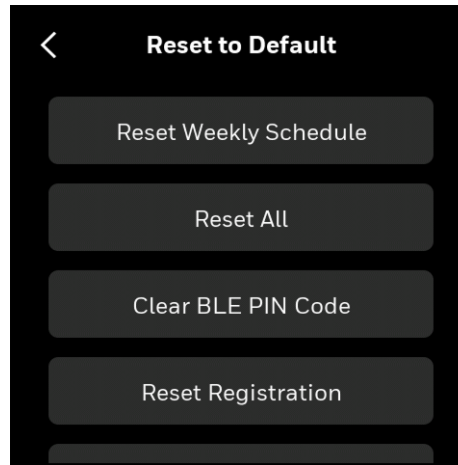
User can reset the entire thermostat to the factory default or reset only temperature setpoints and schedule to factory default.

### To restore the factory default setting

1. Swipe left from the Home page.
2. Tap **Config** > scroll down > **Reset to Default**.  
The Reset to Default page appears.

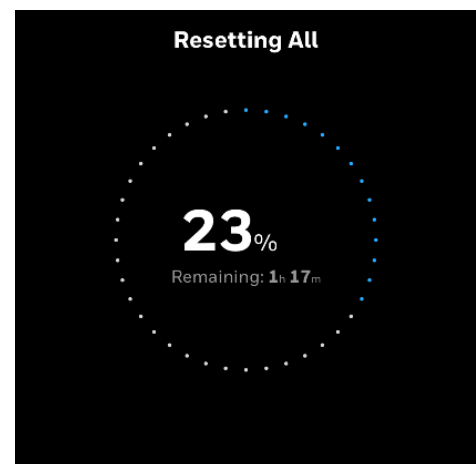
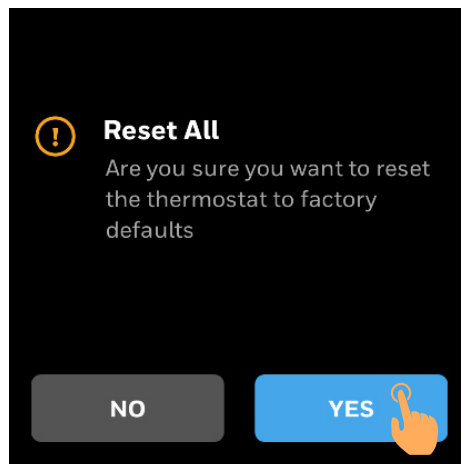


Figure 157 Reset All



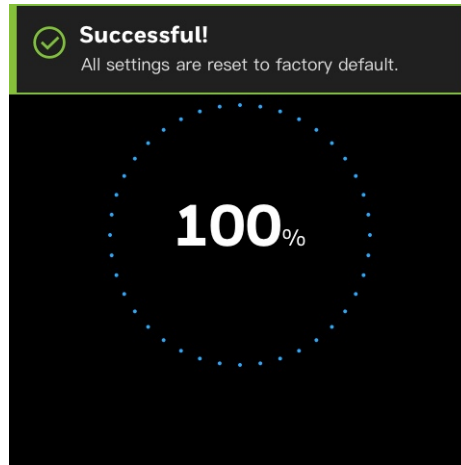
3. Tap **Reset Weekly Schedule** to only reset the temperature and schedule setpoint. It retains other configurations. Refer to [Resetting a schedule](#).
4. Tap **Reset All** to fully reset the thermostat. It deletes all the configurations and user data.
5. Tap **CLEAR BLE PIN Code** to erase the BLE PIN code.  
A confirmation message appears.
6. Tap **YES**. The Successful message appears.
7. Tap **Reset Registration** to remove the registration from the cloud.

Figure 158 Reset typical pages



8. Upon successful reset, user will be notified by a notification banner.

Figure 159 Reset All



This chapter explains alarms and its configuration procedures.

**Related topics**

[Alarms](#)

[Alarm notification signs](#)

[Alert notification](#)

[Unacknowledged alarms](#)

[List of alarms and their severity](#)




[Managing the alarms](#)

## Alarms

In the TC500A thermostat, alarms are configured for predefined set values. When the values are breached, the alarms are triggered and displayed on the home page as banner notification, dot notification, and on the Alert button. You can view the triggered alarms and acknowledge them.

## Alarm notification signs

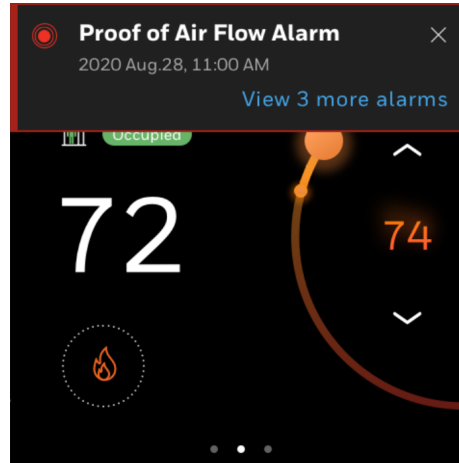
The alarm menu notification icon has three color codes to indicate the severity of the alarm. The following table describes the available signs with color codes of the alarm pages.

Icons	Description
	High
	Medium
	Low

## Alert notification

The alerts of alarms can be configured as banner notification or dot notification as per the Alert configuration. The banner notification is pop-up on the home page whereas the dot notification appears beside the Wi-Fi icon. For alert configuration, refer to [Configuring the alarm preference](#).

Figure 160 Alarm banner notification



You can tap the banner notification to view the alarm and acknowledge it. If multiple alarms are triggered then the latest one (high) will be displayed on the home page. After tapping the banner, it takes you to the **Alarm** page.

- High - Red color banner
- Medium - Orange color banner
- Low - Yellow color banner

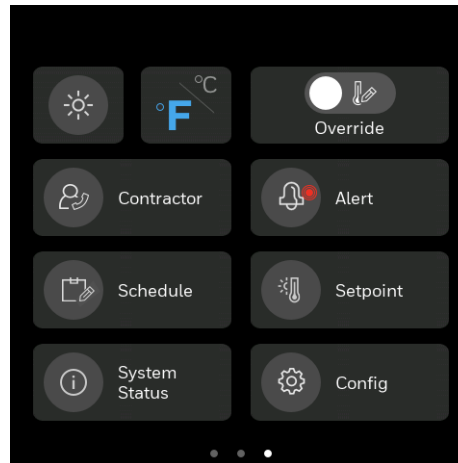
## Unacknowledged alarms

In addition to the banner notification, all other alarms (for which the notification is not configured) can be viewed and acknowledged under the Alert page. The Alert tab displays the alarms that have not been acknowledged by the user. If there are unacknowledged alarms, the Alert button will have a visual notification as per the severity of the alarm.

### To view the unacknowledged alarms

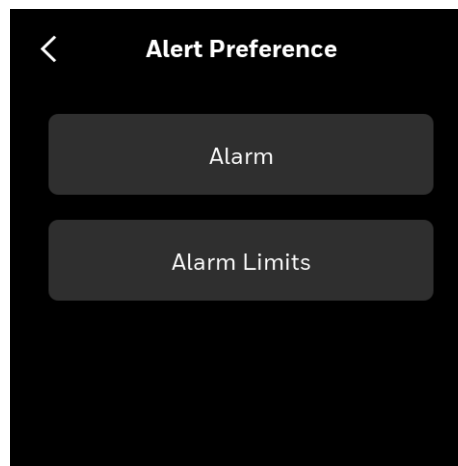
1. Swipe left from the Home page.
2. On the Quick access page, tap the bell (Alert) icon.  
The Alert Preference page appears.

Figure 161 Home page - Alert Tab



3. Tap **Alarm**.  
A list of unacknowledged alarms appears.

Figure 162 Alert preference - Alarm



**Note:** Under the ALARM tab, tap the Red, orange, or yellow-colored Alarms. The relevant data points list appears to acknowledge the alarms.

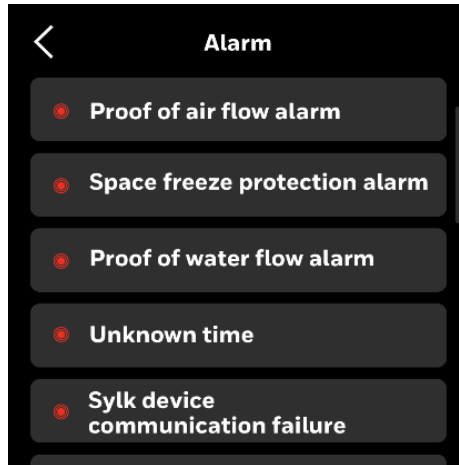
**Red** icon: Displays only the data points with High severity alarm.

**Orange** icon: Display only the data points with Medium severity alarm.

**Yellow** icon: Display only the data points with Low severity alarm.

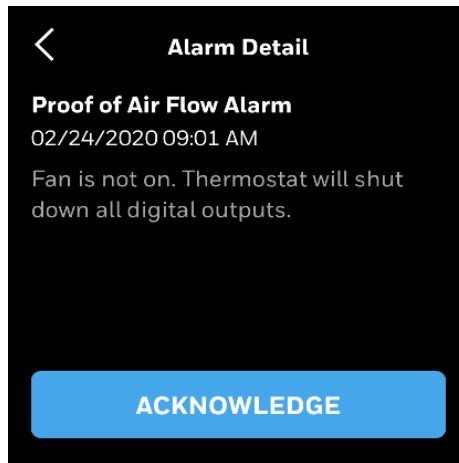
4. Tap an Alarm name.  
The corresponding alarm property page appears. The alarm property page describes the nature of event state transition.

Figure 163 Alarm page - Select the alarm



5. Tap **ACKNOWLEDE** to view additional information and acknowledge the alarm.

Figure 164 Acknowledge alarms

**Note:**

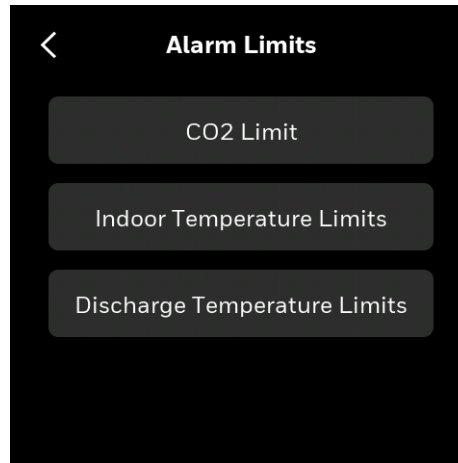
- Except for Alarms "Unknown Time" and "Wi-Fi Network Not Configured" all alarms can be acknowledged by tapping ACKNOWLEDGE.

- For "Unknown Time", the set Date and Time page appears. Click SAVE to acknowledge alarms.

- For "Wi-Fi Network Not Configured", Configuration Settings appear. Select the Wi-Fi network to acknowledge the alarms.

6. On the **Alert Preference** page, tap **Alert Limits**.  
The Alarm Limits page appears.

Figure 165 Alarm limits

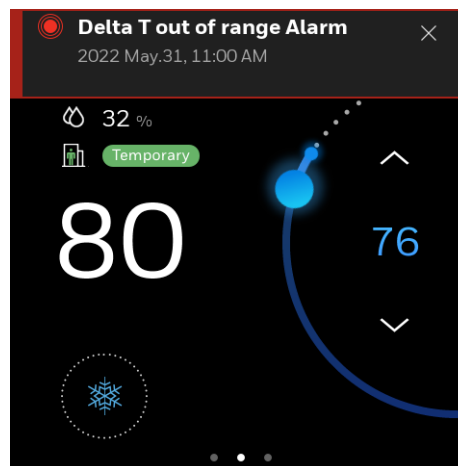


7. Tap **CO2 Threshold Limits** to set the CO2 ppm limits.
8. Tap **Indoor Temperature Limits** to set the indoor temperature limits.
9. Tap **Discharge Temperature Limits** to set the alarm for discharge temperature.

## Managing Delta T alarms

If Delta T is configured then the related alarms are displayed as banner notification or dot notification on the thermostat.

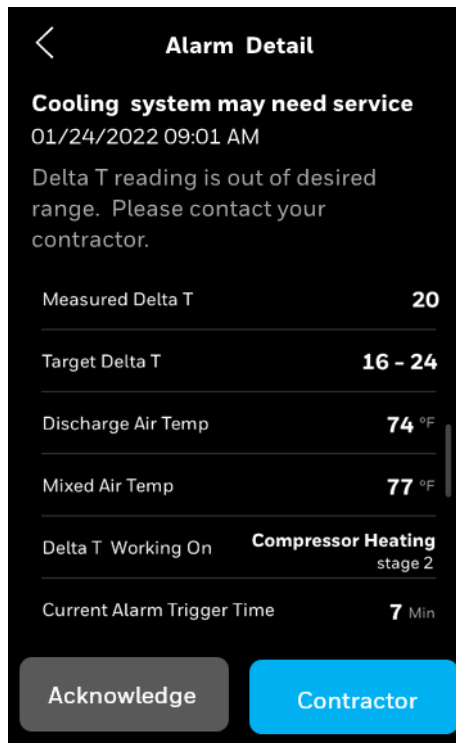
Figure 166 Delta T banner notification



Red colored banner - Delta T reading is at a critical range, more than 5 °F outside range.  
 Orange colored banner - Delta T reading is less than 5 °F outside range.

1. Tap the banner notification to view the alarm details.  
 The alarm detail page appears.

Figure 167 Delta T alarm detail



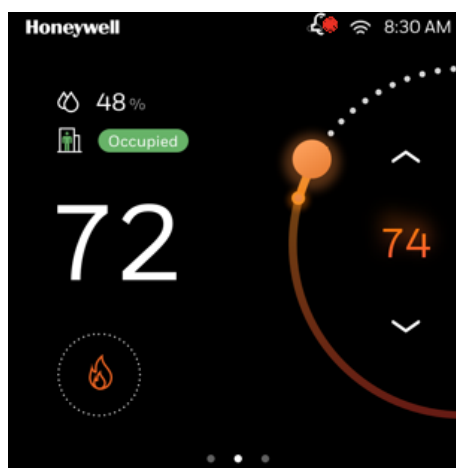
The alarm detail page displays the title of the alarm, description, and Delta T parameters. The list of parameters vary according to the equipment and Delta T configuration.

2. Tap **Acknowledge** to acknowledge and close the page, or if required tap **Contractor**, to see contractor information to service the equipment.

## Dot notification

The dot notification appears on the home page and on the alarm icon of the configuration page.

Figure 168 Delta T alarm - dot notification



1. Swipe left from the Home page.



2. On the Quick access page, tap the bell (Alert) icon.  
The Alert Preference page appears.
3. Tap **Delta T Alarm**.

## List of alarms and their severity

The list of alarms in the Commercial Connected thermostat is as follows

<b>Alarms</b>	<b>Severity</b>
Proof of Air Flow Alarm (fan state)	High
Space Freeze Protection Alarm	High
Proof of water flow Alarm	High
CO2 sensor failure	High
Outdoor air sensor failure	High
Mixed air sensor failure	High
Discharge Air Temperature sensor failure	High
Space Temperature Sensor Failure	High
Space Humidity Sensor Failure	High
Sylk Device Communication Failure	High
Space Humidity Sensor Failure	Medium
Sylk Device Communication Failure	Medium
Internal Proximity Sensor Failure	Medium
WiFi Network Not Configured	Medium
Unknown Time	Medium
Discharge Air Temperature out of range alarm	Medium
Space Temperature out of range alarm	Medium
Mixed Air Temperature out of range alarm	Medium
Outdoor air Temperature out of range alarm	Medium
CO2 out of range alarm	Medium
WiFi Connection Lost	Low
Space CO2 Limit Exceeded alarm	Medium
Economizer Fault alarm	High
Honeywell cloud connection failure alarm	High
Honeywell cloud connection not detected	High
Packaged Economizer fault alarm	High
Actuator failure alarm	High
Coil freeze protection alarm	High
Return Air sensor failure alarm	High

<b>Alarms</b>	<b>Severity</b>
Return Air temperature out of range alarm	Medium
Window open detection alarm	High
Shutdown alarm	High
Delta T out of range alarm	High/Medium
Drain Pan Sensor alarm	High

## Managing the alarms

Alarm	Trigger Scenario	Action	Level
Proof of Air Flow Alarm (fan state)	<p>1.An input (such as a current switch or differential pressure switch) shall be available to monitor proof of air flow in the Rooftop Unit. When configured, the control will monitor this digital input once per second.</p> <p>2.If the fan should be on, then it is not on, should generate an alarm and disable stages.</p> <p>For example, if the stage should be on, then digital input indicates no air flow for 10 consecutive seconds.</p>	<p>depend on the alarm configuration:</p> <p>1.Display indicator: It will generate an alarm and alarm indicator is displayed.</p> <p>2.Interlock stage: the control shuts down all digital outputs and will continue to try to restart the fan.</p>	High
Space Freeze Protection Alarm	<p>The frost alarm shall occur if space temperature drops below 42.8°F (6°C) even when the controller is in manual mode, night purge mode, or pressurize/depressurize.</p> <p>No frost alarm shall occur if the controller is disabled, in test mode, or in some higher priority mode as defined by the application.</p>	<p>The alarm shall be sent within 2 minutes of the temperature sensor going below the frost setpoint. The heating and fan output will be enabled until the room temperature reaches 46 °F (8°C) or the thermostat is turned on.</p>	High
Proof of water flow Alarm	<p>1.Heat pump proof of water is for water source heat pumps only and needs extra configuration (water flow detector).</p> <p>2.If the stage should be on, then the input indicates loss of water flow in a Heat pump application.</p> <p>3.There are 2 options by which user can send the proof of water flow. If we receive no proof from neither of those then we will generate an alarm after 10 seconds.</p> <p>1. Physical Input - UI/UIO terminal input 2. Network Input - WSHP Enable &amp; WSHP value points</p>	<p>depend on the alarm configuration:</p> <p>1..Just displays indicator: It will generate an alarm and alarm indicator is displayed.</p> <p>2.Interlock stage: The controller shall disable the heat pump compressor and report an alarm.</p>	High
Sylk Device Communication Failure	<p>if any one of the Sylk sensor fails, the alarm will be triggered.</p>	<p>1.If the sensor is used to control loop and network temp/humidity space sensors are available, the thermostat will generate an alarm.</p> <p>2.The application shall disable all control functions associated with the failed sensor; i.e. it will react as if the sensor was not configured.</p>	<p>Sensor issue</p> <p>High (Action 2)/ Medium (Action 1)</p>

Alarm	Trigger Scenario	Action	Level
CO2 sensor failure alarm	1.Open/short limit is detected on CO2 sensor(UI1/UI2/UIO1/UIO2) 2. CO2 outside of range(CO2 < Oppm or DA sensor > 2000ppm)	High--The application shall disable all control functions associated with the failed sensor; i.e. it will react as if the sensor was not configured. Medium--CO2 out of range: Will not disable control function, Check equipment for proper operation.	Wiring issue High (failure)/ Medium (out of range)
Outdoor air sensor failure alarm	1.Open/Short limit is detected on outdoor air sensor(UI1/UI2/UIO1/UIO2) 2.OAT outside of range (OA sensor < - 40°F or OA sensor > 150°F)	The application shall disable all control functions associated with the failed sensor; i.e. it will react as if the sensor was not configured. --OAT out of range: Will not disable control function, Check equipment for proper operation.	Wiring issue High (failure)/ Medium (out of range)
Mixed air sensor failure alarm	1.Open/Short limit is detected on mixed air sensor(UI1/UI2/UIO1/UIO2) 2.MAT outside of range: (MA sensor < 40°F or MA sensor > 120°F)	The application shall disable all control functions associated with the failed sensor; i.e. it will react as if the sensor was not configured. -MAT out of range: Will not disable control function, Check equipment for proper operation.	Wiring issue High (failure)/ Medium (out of range)
Discharge air sensor failure alarm	35°F<SA sensor<125°F.(No matter which sensor act as space temperature)  DAT sensor fault: Open/short limit is detected on Discharge air sensor(UI1/UI2/UIO1/UIO2) DAT outside of range: (DA sensor < 35°F or DA sensor > 165°F)	DAT sensor fault: The application shall disable all control functions associated with the failed sensor; i.e. it will react as if the sensor was not configured.  DAT out of range: Will not disable control function, Check equipment for proper operation.	Sensor issue  High (failure)/ Medium (out of range)
Space Temperature Sensor Failure	1. Local Space temp as the main control and sensor fault is detected (High) depend on network value 2. Remote Space temp as the main control. sensor fault is detected (High) depend on network value 3. Multi space temp as the main control. All/Some of the temp sources have sensor fault detected (High/Medium) also depend on network value	1.If the sensor is used to control loop and network temp/humidity space sensors are available, the thermostat will generate an alarm 2.If the sensor is used to control loop and network temp/humidity space sensors are unavailable, the application shall shut down all output control of Heating and Cooling equipment. The fan shall remain under normal control.	Sensor issue High (Action 2)/ Medium (Action 1)
Space Humidity Sensor Failure	1. Local Space Humidity as the main control and sensor fault is detected (High) 2. Remote Space Humidity sensor as the main control fault is detected (High) 3. Multi space Humidity sensor as the main control, All/Some of the temp source have sensor fault detected (High/Medium)	1.If the sensor is used to control loop and network humidity space sensors are available the thermostat will generate an alarm 2.If network temp/humidity space sensors are unavailable the application shall disable all control functions (E.g Humidity control for humidification or dehumidification) associated with the failed sensor.	Sensor issue High (Action 2)/ Medium (Action 1)

Alarm	Trigger Scenario	Action	Level
Space Temperature out of range alarm	Space temperature outside of range (SA sensor < 35°F or SA sensor >125°F).(No matter which sensor act as space temperature)	1.If the sensor is used to control loop and network temp are available thermostat will just generate an alarm. 2.If the sensor is used to control loop and network temp are unavailable, the application shall shut down all output control of Heating and Cooling equipment. The fan shall remain under normal control.	Sensor issue Medium
Internal Proximity Sensor Failure	Onboard proximity sensor fault is detected	The thermostat is the same as that no proximity sensor is configured.	Sensor issue Medium
Unknown Time	Thermostat has been powered off for a long time thus RTC time is lost when the INTERNET is not connected.	Prompt user to set date/time	Medium
WiFi Network Not Configured	If user selects WiFi as the means of communication, then the thermostat isn't configured to join WiFi network	WiFi alarm is displayed on home screen.	Connection issue Medium
WiFi Connection Lost	If user selects WiFi as the means of communication and Thermostat lost WiFi connection with Gateway	WiFi alarm is displayed on home screen.	Connection issue Low
Space CO2 Limit Exceeded	If the CO2 level exceeds the configured high limit.	Visual alert will continue as long as the threshold is exceeded. Alert will be displayed on the main screen.	High
Packaged Economizer Fault	There should be a digital input to detect economizer fault. When this digital input becomes active, an alarm is triggered.	Message states, "Economizer Fault Contact Service". The message will reappear periodically and packaged economizer will be disabled, until resolved.	High
Honeywell Cloud Connection Failure	When the thermostat has lost connection with Forge cloud.	The Thermostat cannot communicate with Forge cloud and Mobile app.	High
Delta T out of range alarm	The thermostat will measure Delta T after the specified run time, and compare Delta T to the minimum and maximum limits for each valid cycle. If the system operates below the minimum limit or above the maximum limit multiple times, and alarm is triggered. If Measured Delta T < minimum limit - 5°F or Measured Delta T > maximum limit + 5°F, report Red level alarm; If minimum limit - 5°F < Measured Delta T < minimum limit or maximum limit < Measured Delta T < maximum limit + 5°F, report Orange level alarm.	Visual alert will continue as long as the threshold is exceeded. Alert will be displayed on the main screen.	High (Red level) and Medium (Orange level)



## About Schedule

TC500A enables you to plan operations based on the time of day and holidays.

This scheduling structure allows you to control day-to-day operations with the standard schedule. The holiday schedule controls days or times when a facility is typically unoccupied. The event schedule controls periods outside normal occupied times. The holiday schedule overrides the standard schedule and the event schedule overrides the holiday and standard schedules within a schedule set.

Schedules use the setpoint configuration of Occupied, Unoccupied, or Standby modes.

Occupied mode treats the building space as occupied and configured with comfort setpoints.

Unoccupied mode treats the building space as not occupied and configured with energy savings setpoints.

Standby mode setpoints are configured in a way that the setpoints can quickly change to the Occupied mode when switched. Standby mode setpoint saves energy higher than occupied mode and lesser than the Unoccupied mode.

Temporary mode allows the user to change the temperature setpoints of the Occupied mode after the user switches to the temporary mode from the Occupied mode. This is not possible in Unoccupied mode and Standby mode.

When a schedule uses the Occupied mode but the Occupancy sensor reads unoccupied, then the thermostat switches automatically to the Standby mode. In other scenarios, the thermostat follows the schedule status and the occupancy sensor's value has no impact on it.

## How schedules works

When you set up schedules, it is important to understand the relationship of the schedules in the schedule set and how to use each one.

- **Standard schedule:** Use the weekly schedule to program occupied and standby periods for each of the week.
- **Holiday schedule:** Use holiday schedules to set holidays that “float” or occur on a specific date each year. Up to 20 holidays can be created.

- **Special event:** Use Special event to schedule one-time events.

**Note:** *Holiday schedules automatically write a 12:00 AM OFF time, which is in effect unless it is overridden by an event schedule.*

### Related topics

[Setting up a weekly schedule](#)

[Resetting a schedule](#)

[Setting up a holiday schedule](#)

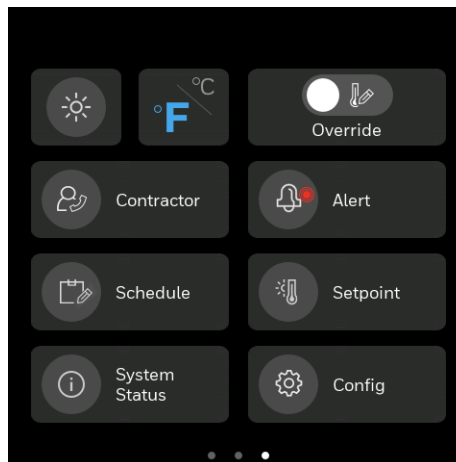
[Special event](#)

## Setting up a weekly schedule

### To add a new time value to a weekly schedule

1. Swipe left from the Home page.  
The Quick access page appears.

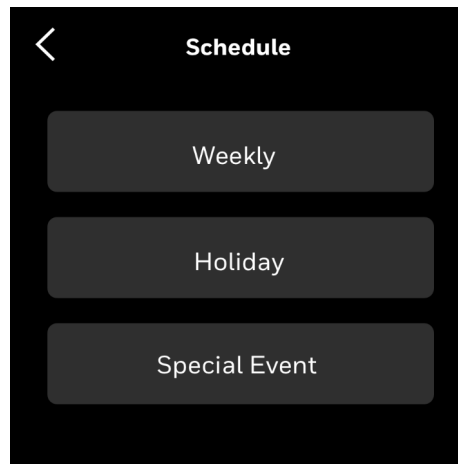
**Figure 169** Quick access page



2. On the Quick access page, tap **Schedule**.  
The schedule main page appears which lists all types of schedules available in the thermostat.

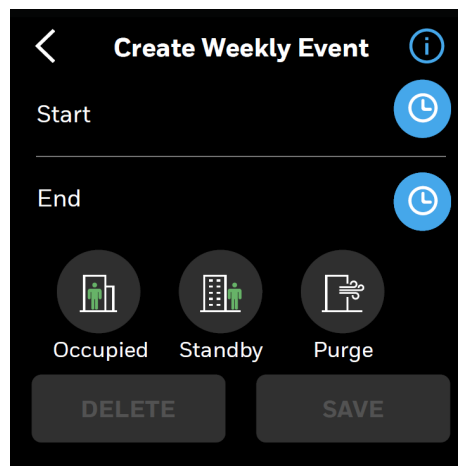


Figure 170 Schedule types



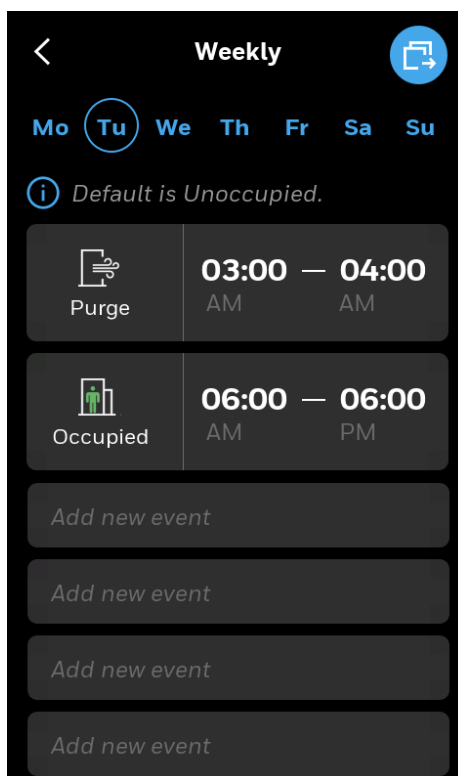
3. Tap **Weekly** to add a new schedule.  
The Create Weekly Event page appears.  
It displays three event types for scheduling. Occupied, Standby, and Purge. The Purge option appears only if the purge conditions are configured.

Figure 171 Weekly event page



4. Tap the information icon to read the schedule events limits.
5. Set the start and end time for the event.
6. Tap an event type (Occupied or Standby or Purge).
7. Tap **SAVE**.  
The Weekly page appears. It displays the created schedule under Monday. You can copy the schedule to other days. Refer to [Copying the schedules from one day to another](#).

Figure 172 Weekly schedule



**Note:** If the purge is disabled in the system, then purge related schedules are de-activated.

8. To add another schedule, tap **Add new event**.
9. Tap the back button to exit the scheduling.

**Note:** System would be unoccupied automatically outside the scheduled time slot.

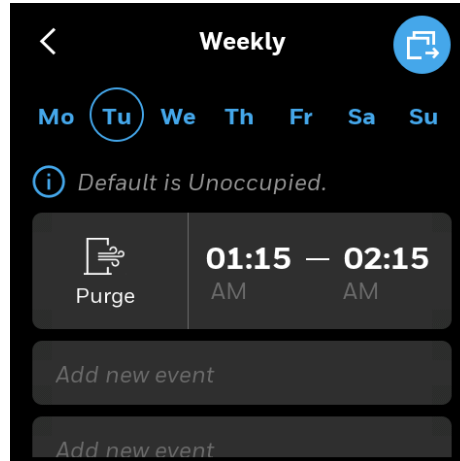
## Editing or deleting weekly schedules

The existing weekly schedules can be edited from the Weekly schedule page.

### To change or delete an existing weekly schedule

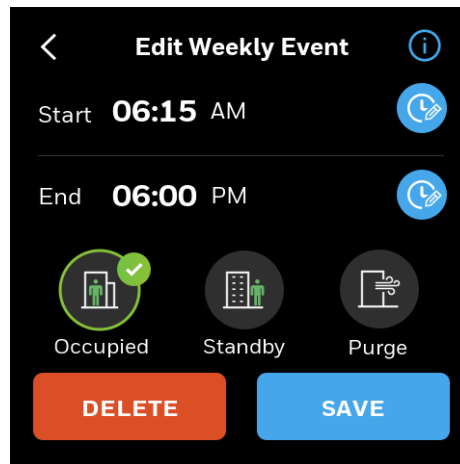
1. On the **Weekly schedule** page, tap the schedule to be modified.  
The Edit Event page will appear.

**Figure 173** Editing a regular schedule



2. Select the new Start and End time and mode.
3. Tap **SAVE** to save changes or Tap **DELETE** to delete the schedule.

**Figure 174** Edit Event



## Copying the schedules from one day to another

The TC500A enables the user to copy an existing regular schedule.

### To copy a schedule from one day to another


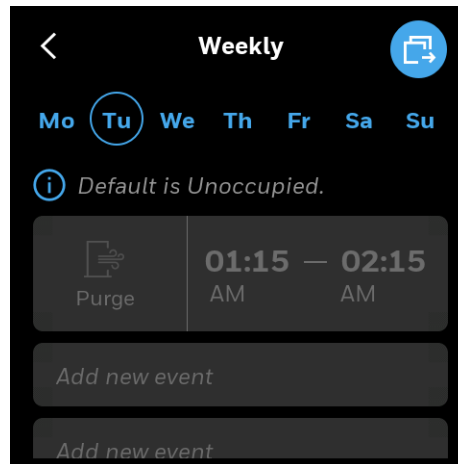
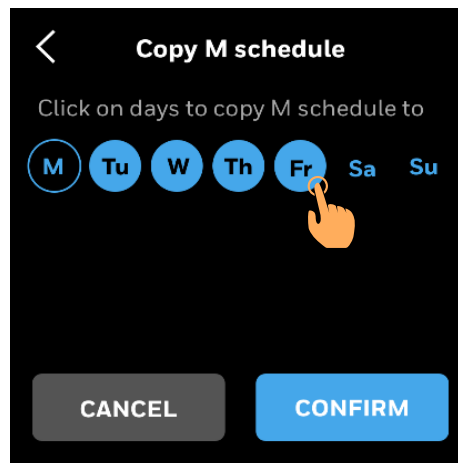
1. Navigate to the Weekly schedule page from where the schedule is to be copied. Select a day to copy.
2. Tap  to copy schedules from Monday. Copy screen will appear.

Figure 175 Copy Schedule



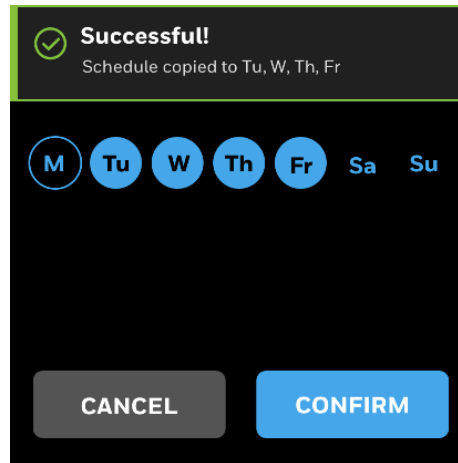
3. Tap on the days of the week for which schedule is to be copied.

Figure 176 Select Days



4. Tap **CONFIRM**.  
Schedule copied successful confirmation message appears.

Figure 177 Copy successful



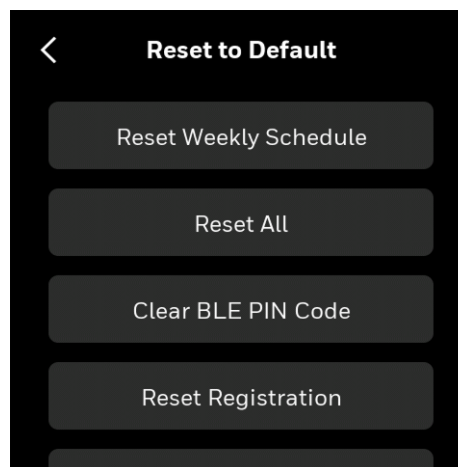
## Resetting a schedule

Resetting schedule will reset the weekly schedule and setpoints of occupied, unoccupied, and standby to factory default.

### To reset all the schedule

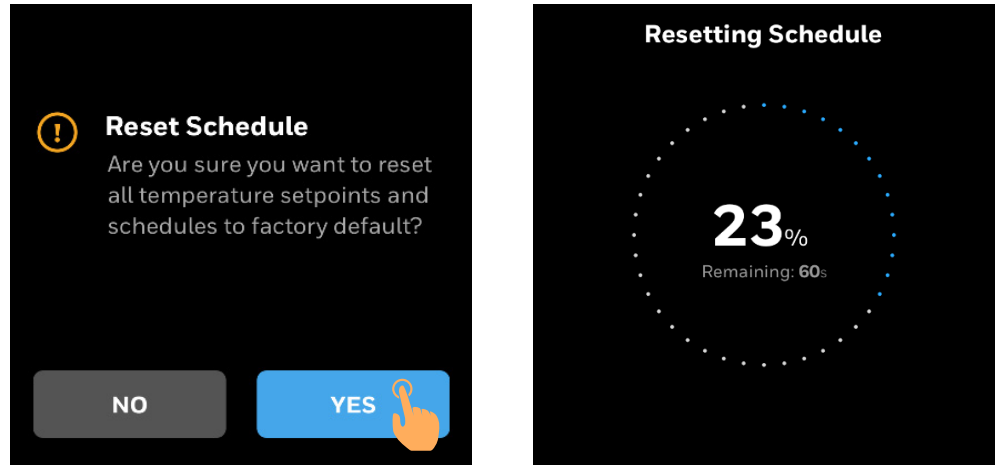
1. On the Home page, tap the **Config** > scroll down > **Reset to Default**.  
The Reset to Default page appears.
2. Tap **Reset Schedule**.  
User will be prompted to confirm the action before reset.

Figure 178 Reset Schedule



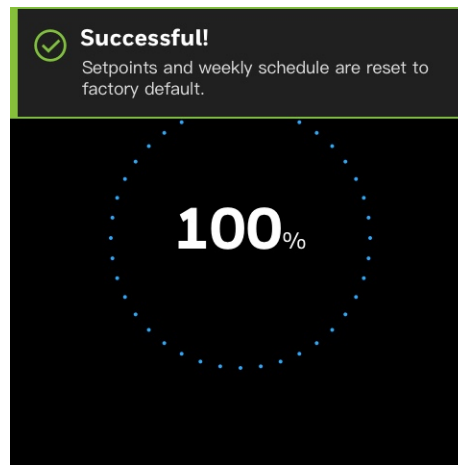
3. Tap **YES** to reset schedule.  
The progress screen appears.

Figure 179 Reset Schedule



4. Upon a successful reset, the user will be notified by a notification banner.

Figure 180 Reset Confirmation



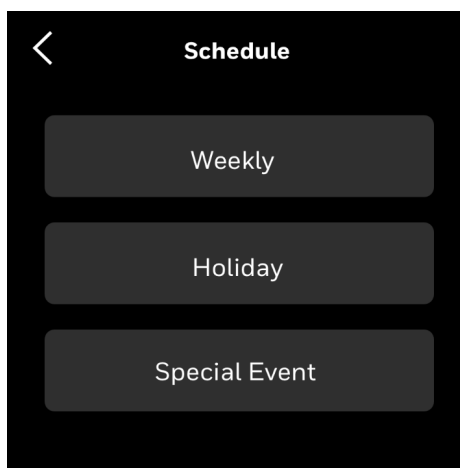
## Setting up a holiday schedule

Holidays are defined as reoccurring events that are different from the weekly schedule, can be Occupied or Standby, or by default Unoccupied. So the Unoccupied/Standby mode setpoints will be executed on the holidays. There are two holiday types are available to choose. There are **Floating date** and **Specific date**. Only one day can be selected for the floating holiday type whereas multiple days can be selected for Specific date type.

### To schedule a holiday

1. Swipe left from the Home page.
2. On the Quick access page, tap the Schedule icon.  
The schedule page appears.

Figure 181 Schedule types




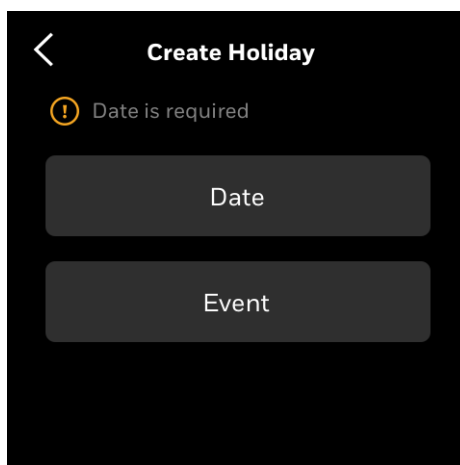
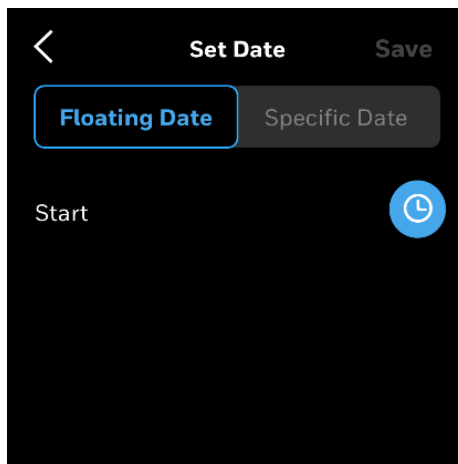
3. Tap **Holiday** to add a new holiday schedule.  
The Holiday page appears.
4. Tap  to add a Holiday.  
The Create Holiday page appears.

Figure 182 Creating Holiday



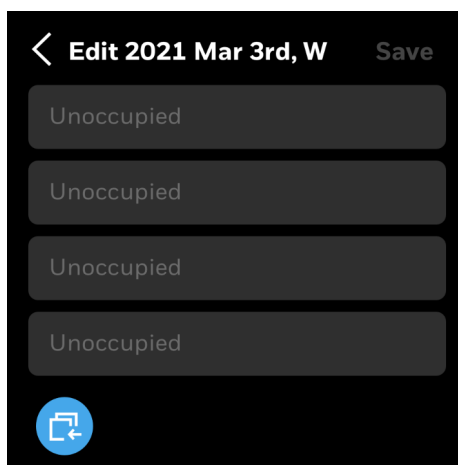
5. Tap **Date**.  
The Set Date page appears.

Figure 183 Set Date



6. Tap **Floating Date** to schedule a floating date as a holiday (Organization related holidays) or tap Specific Date to schedule festival holidays, government holidays, or public holidays.  
If Floating date is selected, then you can choose only one day to create an event.
7. Tap the clock icon.
8. Select a date.
9. Tap **CONFIRM**.  
The Set Date page appears. If you are configuring a Specific Date holiday type, then you can add multiple days by tapping the **How is the holiday** with first date is fixed date.
10. Tap **Save**.  
The Create Holiday page appears.
11. Tap **Event** to configure the actions to be executed on the configured holiday (s).
12. Tap **Set Event**.  
Event list page for the set date appears. You can add a maximum of four events.

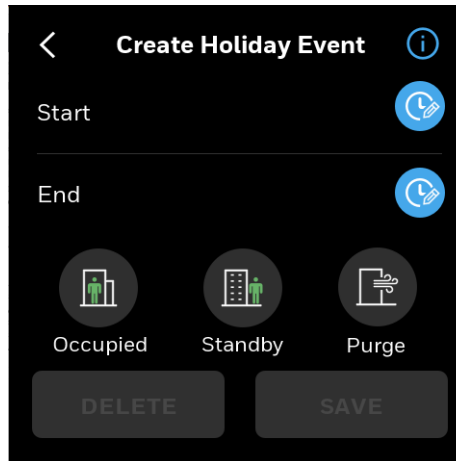
Figure 184 Date page for special events



13. Tap an Unoccupied cell.  
The Create Holiday Event page appears.



Figure 185 Create holiday vent page



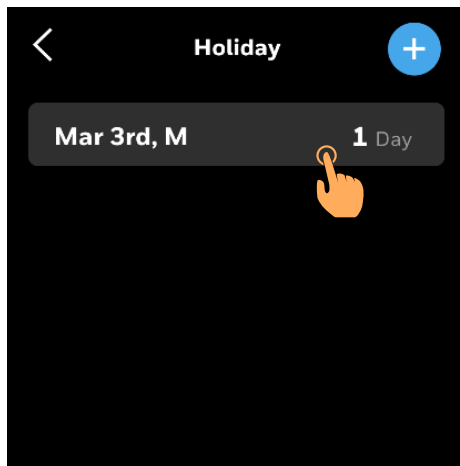
14. Tap the Start clock icon to set the event start time.
15. Set the start time and then tap **CONFIRM**.
16. Tap the End clock icon.
17. Set the event end time and then tap **CONFIRM**.
18. Tap **Occupied** or **Standby** based on your requirement.
19. Tap **SAVE**.  
The created event appears on the Holiday page.
20. Tap **SAVE**.
21. Tap **Done**.  
The holiday creation successful message appears.

## Deleting a holiday schedule

### To delete a holiday

1. On the **Holiday** page, swipe right to delete Holiday.  
Trash bin appears on right.

Figure 186 Select Holiday




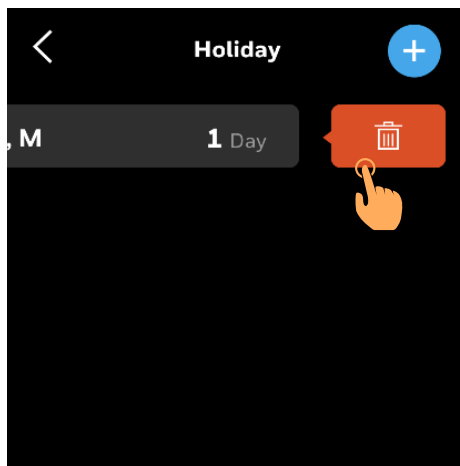
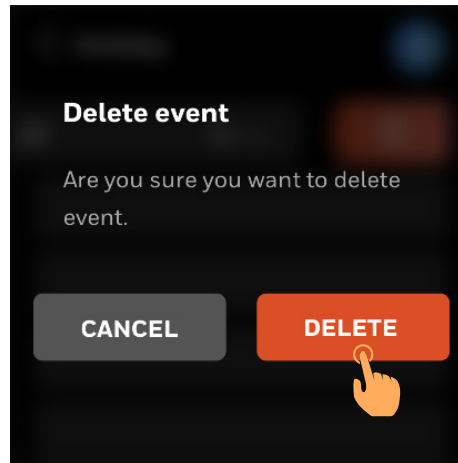
2. Tap  to delete the Holiday.

Figure 187 Delete Holiday



3. User will be prompted to confirm to delete the holiday.
4. Tap **DELETE**.

Figure 188 Pop up to delete Holiday



5. The holiday will be deleted.

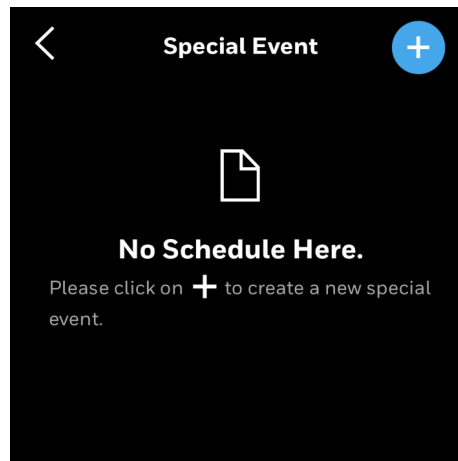
## Special event

Special events are one time events that are different from the weekly schedule.

### To create a special event

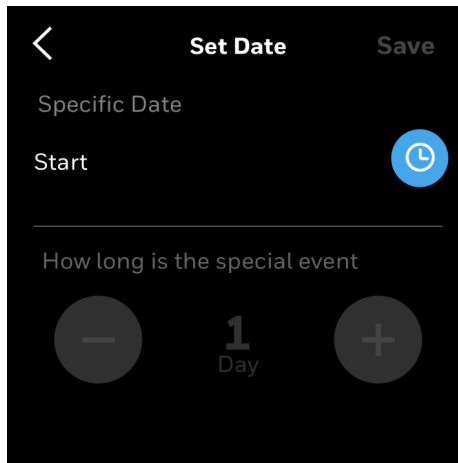
1. Right swipe the home page.
2. On the Quick access page, tap **Schedule** and then tap **Special Event**.  
The Special Event page appears.

Figure 189 Special event page



3. On the top right, tap the add button.  
The **Create Special Event** page appears. Date is mandatory to create a special event.
4. Tap **Date**.  
The Set Date page appears.

Figure 190 Set date page

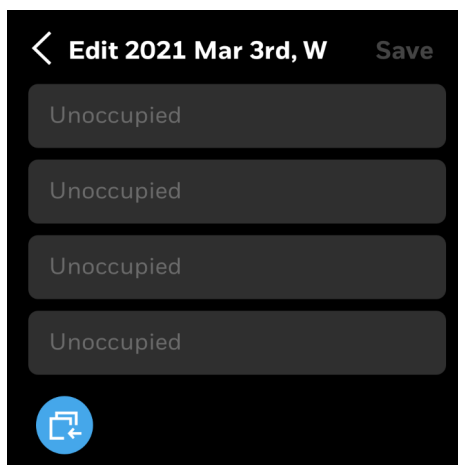


5. Tap the clock icon.
6. Select a year, scroll and select a date, day, and month.

**Note:** *The thermostat supports special event configuration only for three years from the current date.*

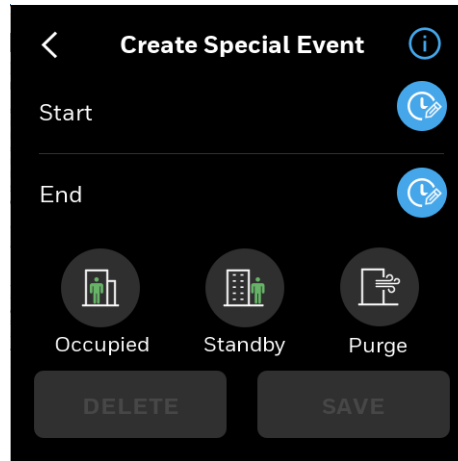
7. Tap **CONFIRM**.  
The Set Date appears.
8. If the special event reoccurs on multiple days, then increase the holiday count.
9. Tap **Save**.
10. Tap **Done**.  
The **Create Special Event** page appears.
11. Tap **Set Event**.  
Event list page for the set date appears. You can add a maximum of four special events for the particular date.

Figure 191 Date page for special events



12. Tap an Unoccupied cell.  
The Create Event page appears.

Figure 192 Create Event page



13. Tap the clock icon for Start.
14. Set the special event start time and then tap **CONFIRM**.
15. Tap the clock for End.
16. Set the special event end time and then tap **CONFIRM**.
17. Tap Occupied or Standby based on your requirement.
18. Tap **SAVE**.  
The created special event appears under the special event date page.
19. Tap **Save**.
20. Tap **Done**.  
You have created a special event.

#### To delete a special event

1. On the special event page, tap a special event.  
A confirmation message appears.
2. Tap **DELETE**.  
The special event is deleted.

**Note:** *Elapsed Special Events will automatically be deleted by the system.*



**Honeywell Building Technologies**

Honeywell  
715 Peachtree Street NE  
Atlanta, GA 30308  
[customer.honeywell.com](https://customer.honeywell.com)  
[buildingcontrols.honeywell.com](https://buildingcontrols.honeywell.com)

® U.S. Registered Trademark  
© 2023 Honeywell International Inc.  
31-00400M-06 | Rev 02-23

THE  
FUTURE  
IS  
WHAT  
WE  
MAKE IT

**Honeywell**